

Specifications for Blanview TFT-LCD Monitor

Version 1.0

(Please be sure to check the specifications latest version.)

MODEL COM37H3N83ULC

Customer's Approval
Signature:
Name:
Section:
Title:
Date:

ORTUSTECH

ORTUS TECHNOLOGY CO., LTD.

Approved by

Toshimasa Ito

Approved by

H. Mori

Checked by

O. Kimura

Prepared by

M. Ito

ORTUS TECHNOLOGY CO.,LTD.

Version History

Ver.	Date	Page	Description
1.0	Dec. 24, 2014	-	-
			First issue

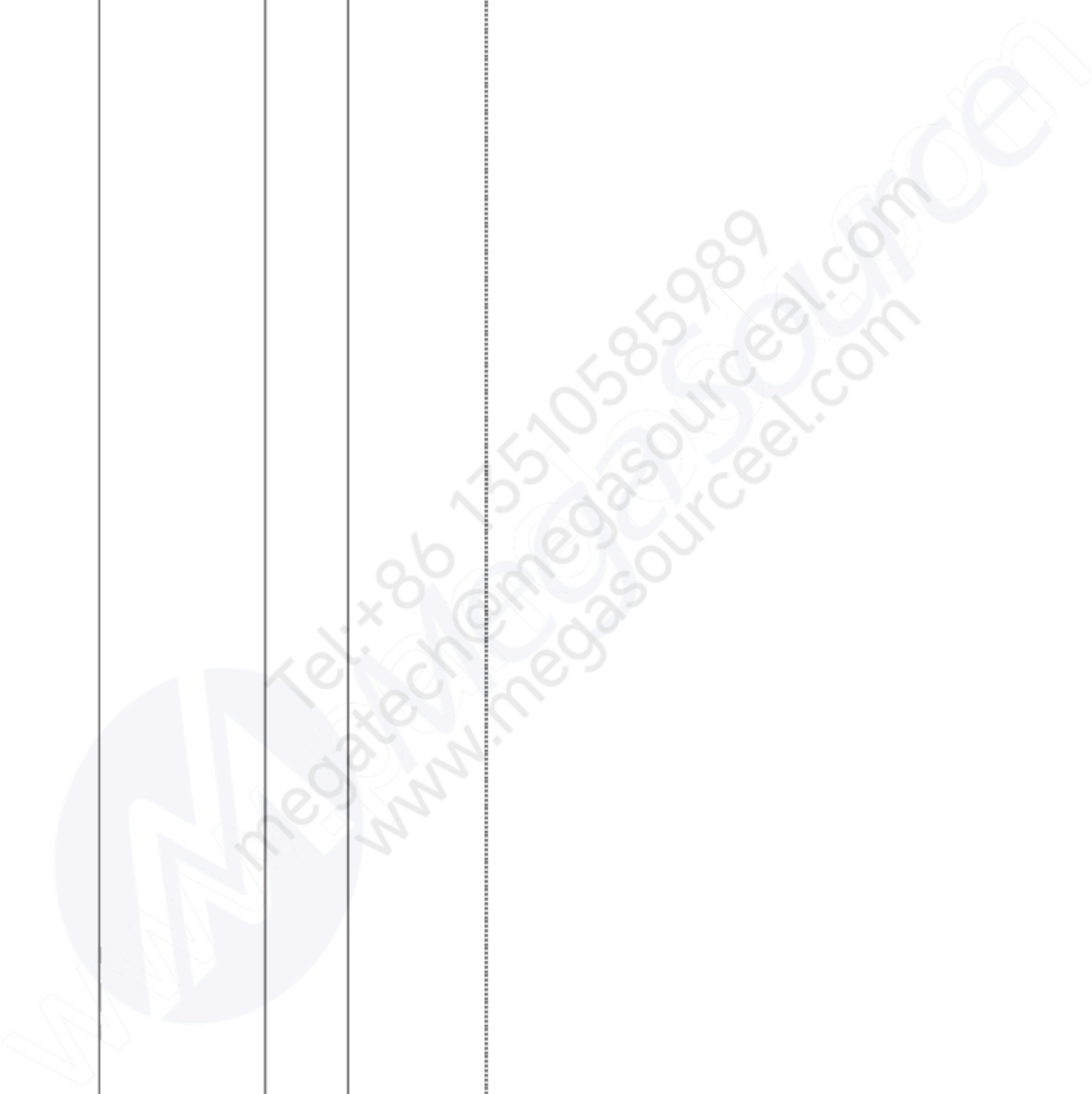

Contents

1. Application	4
2. Outline Specifications		
2.1 Features of the Product	5
2.2 Display Method	5
3. Dimensions and Shape		
3.1 Dimensions	7
3.2 Outward Form	8
3.3 Serial No print (S-print)	9
4. Pin Assignment	10
5. Block Diagram	11
6. Absolute Maximum Rating	12
7. Recommended Operating Conditions	12
8. Characteristics		
8.1 DC Characteristics	13
8.2 AC Characteristics	14
8.3 Input Timing Characteristics	16
8.4 Driving Timing Chart	17
8.5 Example of Driving Timing Chart	18
9. Power-ON/Power-OFF Sequence	19
10. Characteristics		
10.1 Optical Characteristics	20
10.2 Temperature Characteristics	21
11. Criteria of Judgment		
11.1 Defective Display and Screen Quality	22
11.2 Screen and Other Appearance	23
12. Reliability Test	24
13. Packing Specifications	26
14. Handling Instruction		
14.1 Cautions for Handling LCD panels	27
14.2 Precautions for Handling	28
14.3 Precautions for Operation	28
14.4 Storage Condition for Shipping Cartons	29
14.5 Precautions for Peeling off the Protective film	29
APPENDIX	30

1. Application

This Specification is applicable to 9.36cm (3.7 inch) Blanview TFT-LCD monitor for non-military use.

- ⊙ ORTUS TECHNOLOGY makes no warranty or assume no liability that use of this Product and/or any information including drawings in this Specification by Purchaser is not infringing any patent or other intellectual property rights owned by third parties, and ORTUS TECHNOLOGY shall not grant to Purchaser any right to use any patent or other intellectual property rights owned by third parties. Since this Specification contains ORTUS TECHNOLOGY's confidential information and copy right, Purchaser shall use them with high degree of care to prevent any unauthorized use, disclosure, duplication, publication or dissemination of ORTUS TECHNOLOGY'S confidential information and copy right.
- ⊙ If Purchaser intends to use this Products for an application which requires higher level of reliability and/or safety in functionality and/or accuracy such as transport equipment (aircraft, train, automobile, etc.), disaster-prevention/security equipment or various safety equipment, Purchaser shall consult ORTUS TECHNOLOGY on such use in advance.
- ⊙ This Product shall not be used for application which requires extremely higher level of reliability and/or safety such as aerospace equipment, telecommunication equipment for trunk lines, control equipment for nuclear facilities or life-support medical equipment.
- ⊙ It must be noted as an mechanical design manner, especial attention in housing design to prevent arcuation/flexure or caused by stress to the LCD module shall be considered.
- ⊙ ORTUS TECHNOLOGY assumes no liability for any damage resulting from misuse, abuse, and/or miss-operation of the Product deviating from the operating conditions and precautions described in the Specification.
- ⊙ ORTUS TECHNOLOGY is not responsible for any nonconformities and defects that are not specified in this specifications.
- ⊙ If any issue arises as to information provided in this Specification or any other information, ORTUS TECHNOLOGY and Purchaser shall discuss them in good faith and seek solution.
- ⊙ ORTUS TECHNOLOGY assumes no liability for defects such as electrostatic discharge failure occurred during peeling off the protective film or Purchaser's assembly process.
- ⊙ This Product is compatible for RoHS directive.

Object substance	Maximum content [ppm]
Cadmium and its compound	100
Hexavalent Chromium Compound	1000
Lead & Lead compound	1000
Mercury & Mercury compound	1000
Polybrominated biphenyl series (PBB series)	1000
Polybrominated biphenyl ether series (PBDE series)	1000

2. Outline Specifications

2.1 Features of the Product

- 3.7 inch diagonal display, 1440 [H] x 640 [V] dots.
- 6-bit / 262,144 colors.
- Timing generator [TG], Counter-electrode driving circuitry, Built-in power supply circuit.
- Power save (Standby) mode capable.
- Long life & High bright white LED back-light.
- Blanview TFT-LCD, improved outdoor readability.

	Indoor		Outdoor	
	Readability	Power Efficiency (Battery Life)	Readability	Power Efficiency (Battery Life)
Transmissive	Good	Good	Fair	Poor
Transflective	Fair	Poor	Good	Good
Blanview	Good	Good	Good	Good

2.2 Display Method

Items	Specifications	Remarks
Display type	262,144 colors. Blanview, Normally black.	
Driving method	a-Si TFT Active matrix. Line-scanning, Non-interlace.	
Dot arrangement	RGB stripe arrangement.	Refer to "Dot arrangement"
Signal input method	6-bit RGB, parallel input.	
Backlight type	Long life & High bright white LED.	

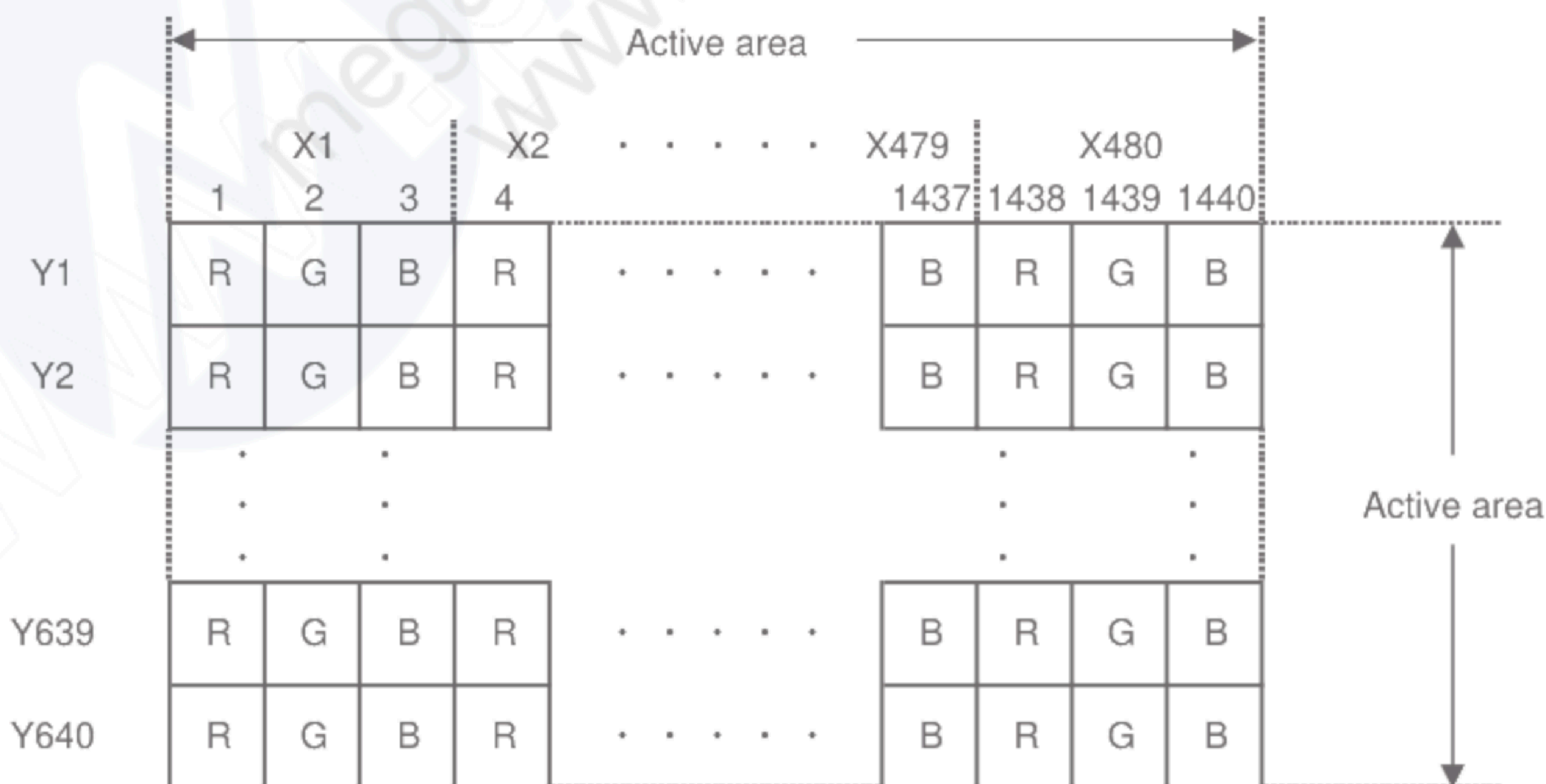

<Features of Blanview>

- Backlight power consumption required to assure visibility. (equivalent to 3.5"QVGA)

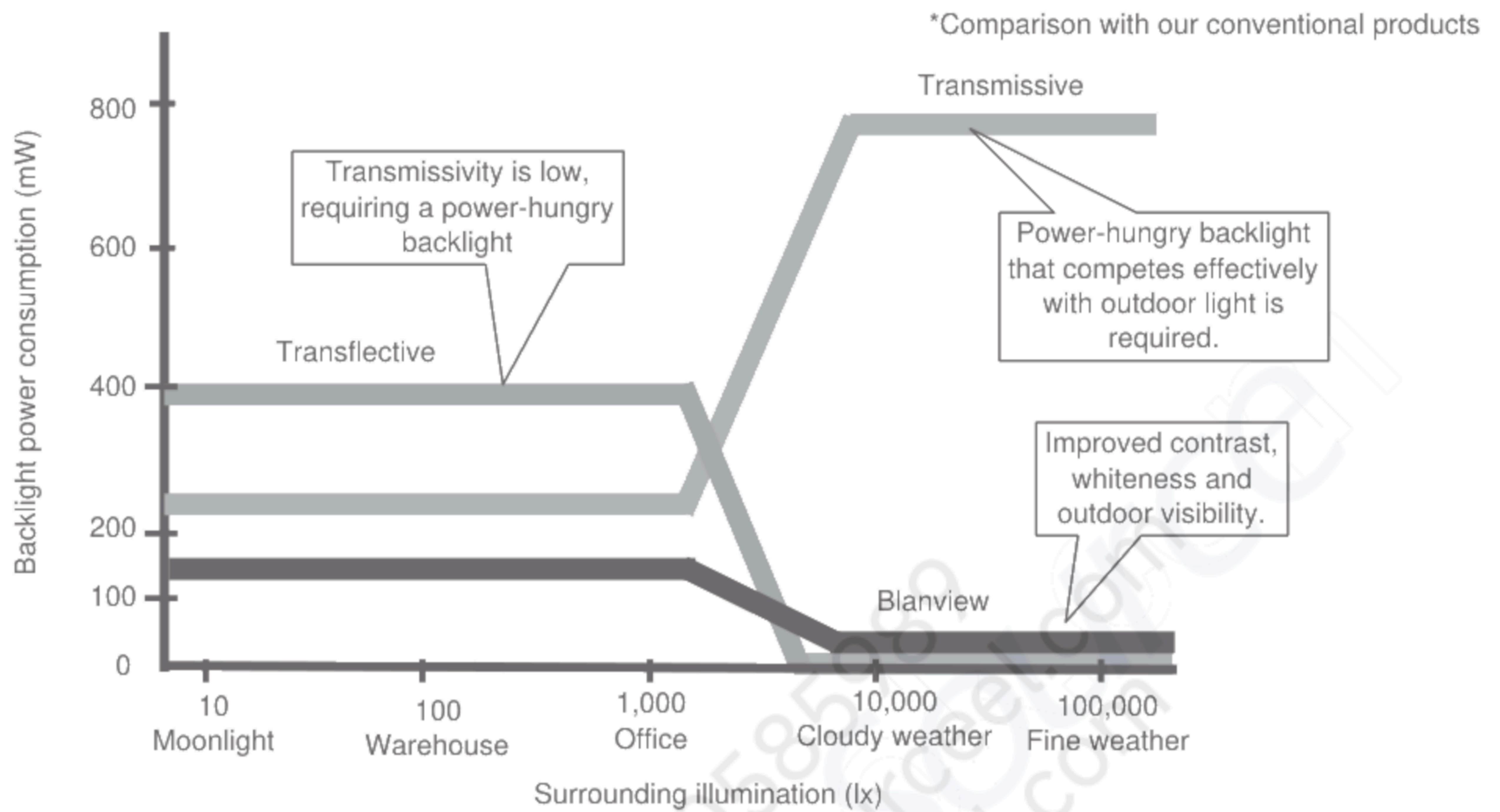

- Contrast characteristics under 100,000lx. (same condition as direct sunlight.)

With better contrast (higher contrast ratio), Blanview TFT-LCD has the best outdoor readability in three different types of TFT-LCD.

Below chart shows contrast value against panel surface brightness. (Horizontal: Panel surface brightness/ Vertical: Contrast value) LCD panel has enough outdoor readability above our Standard line.

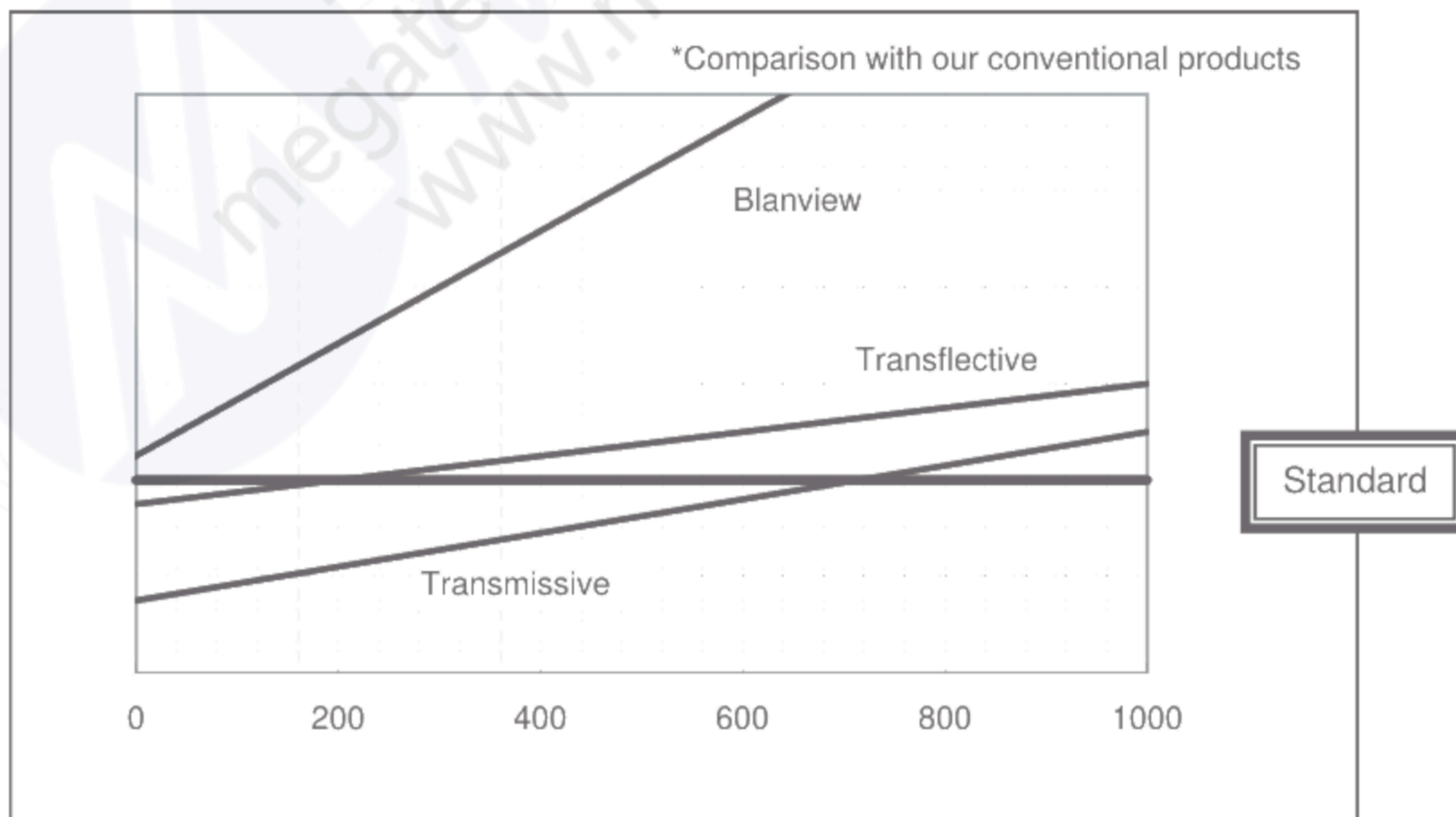

3. Dimensions and Shape

3.1 Dimensions

Items	Specifications	Unit	Remarks
Outline dimensions	65.00[H] × 89.00[V] × 3.00[D]	mm	Exclude FPC cable and parts on FPC.
Active area	56.16[H] × 74.88[V]	mm	9.36cm diagonal
Number of dots	1440[H] × 640[V]	dot	
Dot pitch	39.0[H] × 117.0[V]	μm	
Surface hardness of the polarizer	2	H	Load:2.0N
Weight	31.8	g	Include FPC cable

3.2 Outward Form

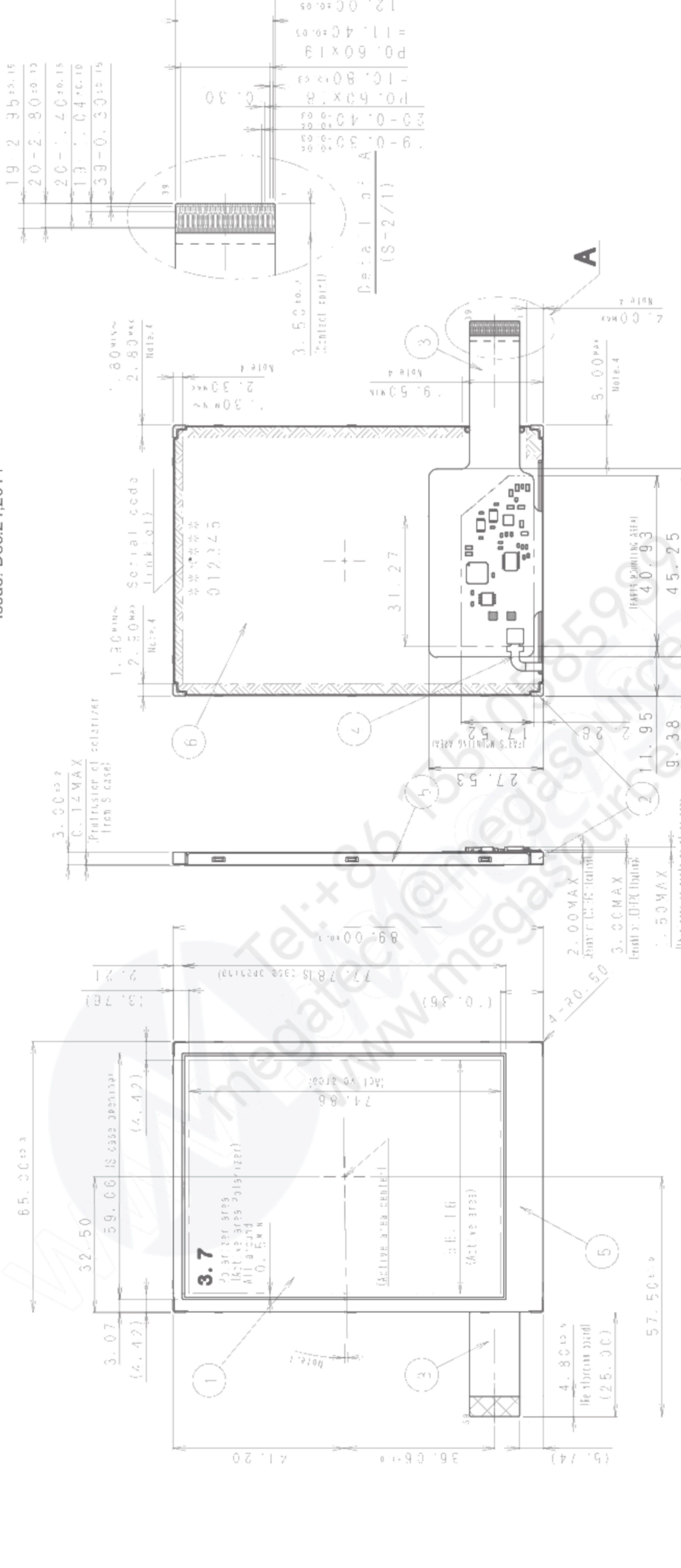

APPROVAL	DESIGN	SCALE	DATE	REVISE	DATE	REVISE	DATE	REVISE
1	1	1/1 (2/1)	19-02-2014	1	19-02-2014	1	19-02-2014	1
CHECKED	ISSUE	MODIFY	MODEL	COM3	PC3NB3	COM3	PC3NB3	COM3
CHECKED	NAME	NAME	NAME	NAME	NAME	NAME	NAME	NAME
DESIGN	DESIGN	DESIGN	DESIGN	DESIGN	DESIGN	DESIGN	DESIGN	DESIGN
DRAWING	DRAWING	DRAWING	DRAWING	DRAWING	DRAWING	DRAWING	DRAWING	DRAWING

Note 1. Angular deviation of LCD cell from the TFF-LCD monitor's reference axis shall be less than [140°]

Note 2. Recommended PC connectors for LCD: 10050. Part number: E23 335 0 35-W (C5)

Note 3. Protective film is affixed on front surface of the screen. Location of the protective film shall be 1.5 mm from the polarizing film.

Note 4. In case of LCD monitor is fixed to the case of your product, it's recommended that monitor's fixax in the area.

Note 5. Refer to "1. CRITERIA OF JUDGMENT" about the appearance specification of a monitor.

3.3 Serial No print (S-print)

1) Display Items

S-print indicates the least significant digit of manufacture year (1 digit), manufacture month with below alphabet (1 letter), model code (5 characters), serial number (6 digits).

* Contents of Display

* * ***** *****
 - - ----- -----
 a b c d

Contents of display																	
a	The least significant digit of manufacture year																
b	<table border="1"> <tr> <td>Manufacture month</td> <td>Jan-A</td> <td>May-E</td> <td>Sep-I</td> </tr> <tr> <td></td> <td>Feb-B</td> <td>Jun-F</td> <td>Oct-J</td> </tr> <tr> <td></td> <td>Mar-C</td> <td>Jul-G</td> <td>Nov-K</td> </tr> <tr> <td></td> <td>Apr-D</td> <td>Aug-H</td> <td>Dec-L</td> </tr> </table>	Manufacture month	Jan-A	May-E	Sep-I		Feb-B	Jun-F	Oct-J		Mar-C	Jul-G	Nov-K		Apr-D	Aug-H	Dec-L
Manufacture month	Jan-A	May-E	Sep-I														
	Feb-B	Jun-F	Oct-J														
	Mar-C	Jul-G	Nov-K														
	Apr-D	Aug-H	Dec-L														
c	<table border="1"> <tr> <td>Model code</td> <td>37BHC (Made in Japan)</td> </tr> <tr> <td></td> <td>37BJC (Made in Malaysia)</td> </tr> </table>	Model code	37BHC (Made in Japan)		37BJC (Made in Malaysia)												
Model code	37BHC (Made in Japan)																
	37BJC (Made in Malaysia)																
d	Serial number																

* Example of indication of Serial No. print (S-print)

• Made in Japan

4L37BHC000125

means "manufactured in December 2014, 3.7" BH type, C specifications, serial number 000125"

• Made in Malaysia

4L37BJC000125

means "manufactured in December 2014, 3.7" BJ type, C specifications, serial number 000125"

2) Location of Serial No. print (S-print)

Refer to 3.2 "Outward Form".

3) Others

Please note that it is likely to disappear with an organic solvent about the Serial print.

4. Pin Assignment

No.	Symbol	Function
1	VSS	Ground
2	VSS	Ground
3	VDD	Power supply input.
4	VCCIO	Logic Interface Power supply input.
5	VSS	Ground
6	RESETB	System reset signal input.(Lo: active)
7	HSYNC	Horizontal sync signal input. (Negative polarity)
8	VSYNC	Vertical sync signal input.(Negative polarity)
9	CLK	Clock input for display. (Data Input on the falling edge)
10	VSS	Ground
11	D00	Display data input for (B). 00h for black display D00:LSB D05:MSB Driver IC carries out gamma conversion internally.
12	D01	
13	D02	
14	D03	
15	D04	
16	D05	
17	D10	Display data input for (G). 00h for black display D10:LSB D15:MSB Driver IC carries out gamma conversion internally.
18	D11	
19	D12	
20	D13	
21	D14	
22	D15	
23	D20	Display data input for (R). 00h for black display D20:LSB D25:MSB Driver IC carries out gamma conversion internally.
24	D21	
25	D22	
26	D23	
27	D24	
28	D25	
29	VSS	Ground
30	DE	Input data effective signal. (It is effective for the period of "H")
31	STBYB	Standby signal (Lo:Standby operation,Hi:Normal operation)
32	TEST1	Connect to Ground.
33	NC	OPEN
34	NC	OPEN
35	NC	OPEN
36	NC	OPEN
37	TEST2	Connect to Ground.
38	BLH	LED drive power source. (Anode side)
39	BLL	LED drive power source. (Cathode side)

- Recommended connector: HIROSE ELECTRIC FH23 series [FH23-39S-0.3SHW(05)]
- Please make sure to check a consistency between pin assignment in "3.2 Outward Form" and your connector pin assignment when designing your circuit.
Inconsistency in input signal assignment may cause a malfunction.
- Since FPC cable has gold plated terminals, gilt finish contact shoe connector is recommended.

5. Block Diagram

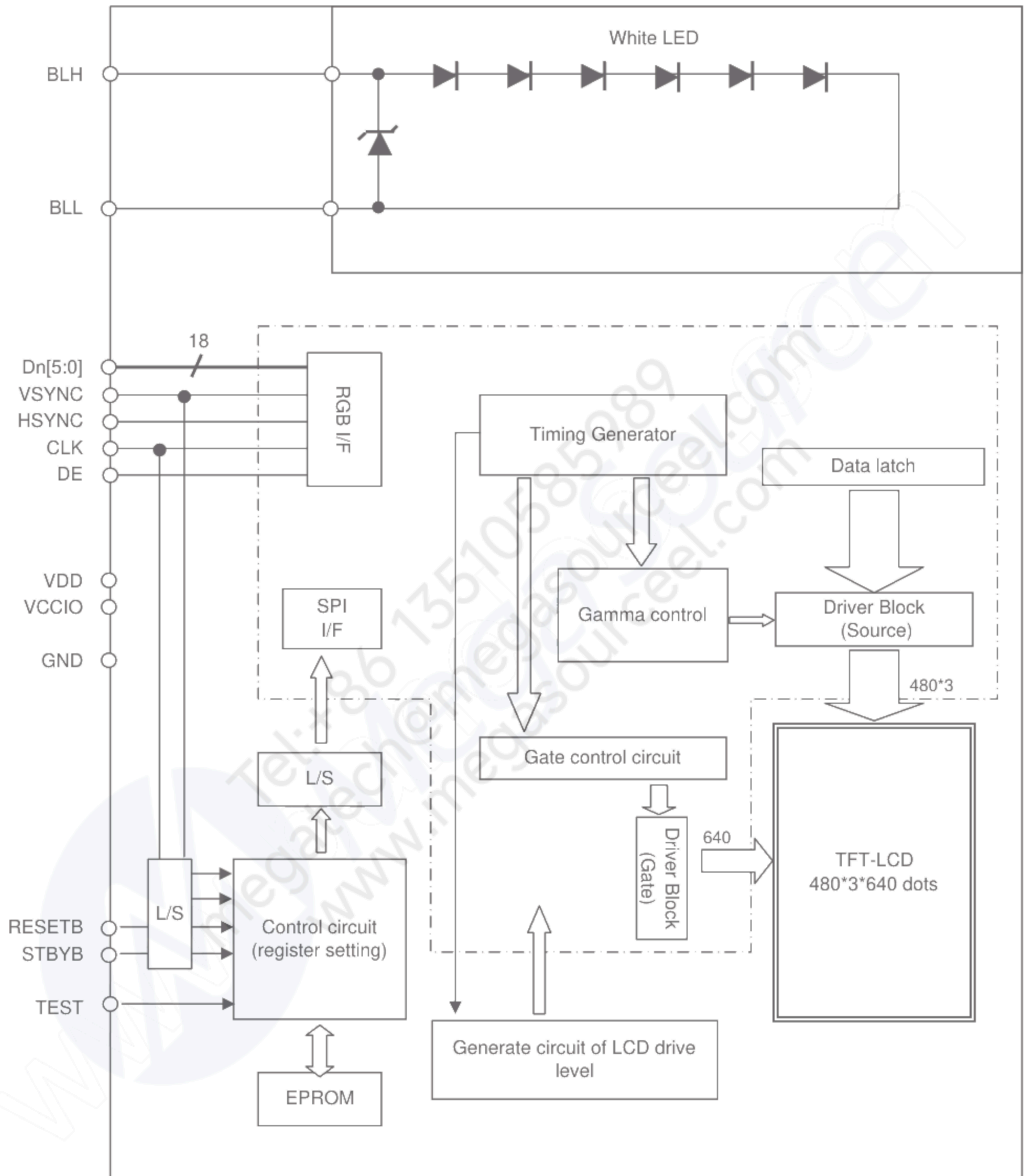

6. Absolute Maximum Rating

VSS=0V

Item	Symbol	Condition	Rating		Unit	Applicable terminal
			MIN	MAX		
Supply voltage	VDD	Ta=25°C	-0.3	4.6	V	VDD
Logic interface voltage	VCCIO		-0.3	VDD	V	VCCIO
Input voltage for logic	VI		-0.3	VCCIO+0.3	V	CLK,VSYNCR,HSYNCR,DE D[05:00],D[15:10] D[25:20],STBYB,RESETB
Forward current	IL	Ta = 25°C	--	35	mA	BLH-BLL
		Ta = 70°C	--	15		
Storage temperature range	Tstg		-30	80	°C	
Storage humidity range	Hstg	Non condensing in an environmental moisture at or less than 40°C90%RH.				

7. Recommended Operating Conditions

VSS=0V

Item	Symbol	Condition	Rating			Unit	Applicable terminal
			MIN	TYP	MAX		
Supply voltage	VDD		2.7	3.0	3.6	V	VDD
Logic interface voltage	VCCIO		1.7	1.8	2.5	V	VCCIO
Input voltage for logic	VI		0	--	VCCIO	V	CLK,VSYNCR,HSYNCR,DE D[05:00],D[15:10] D[25:20],STBYB,RESETB
Operational temperature range	Top	Note1,2	-20	+25	+70	°C	Panel surface temperature
Operating humidity range	Hop	Ta ≤ 30°C	20	--	80	%	
		Ta > 30°C	Non condensing in an environmental moisture at or less than 30°C80%RH.				

Note1: This monitor is operatable in this temperature range. With regard to optical characteristics, refer to Item 10."CHARACTERISTICS".

Note 2: Acceptable Forward Current to LED is up to 15mA, when Ta=+70°C.
Do not exceed Allowable Forward Current shown on the chart below.

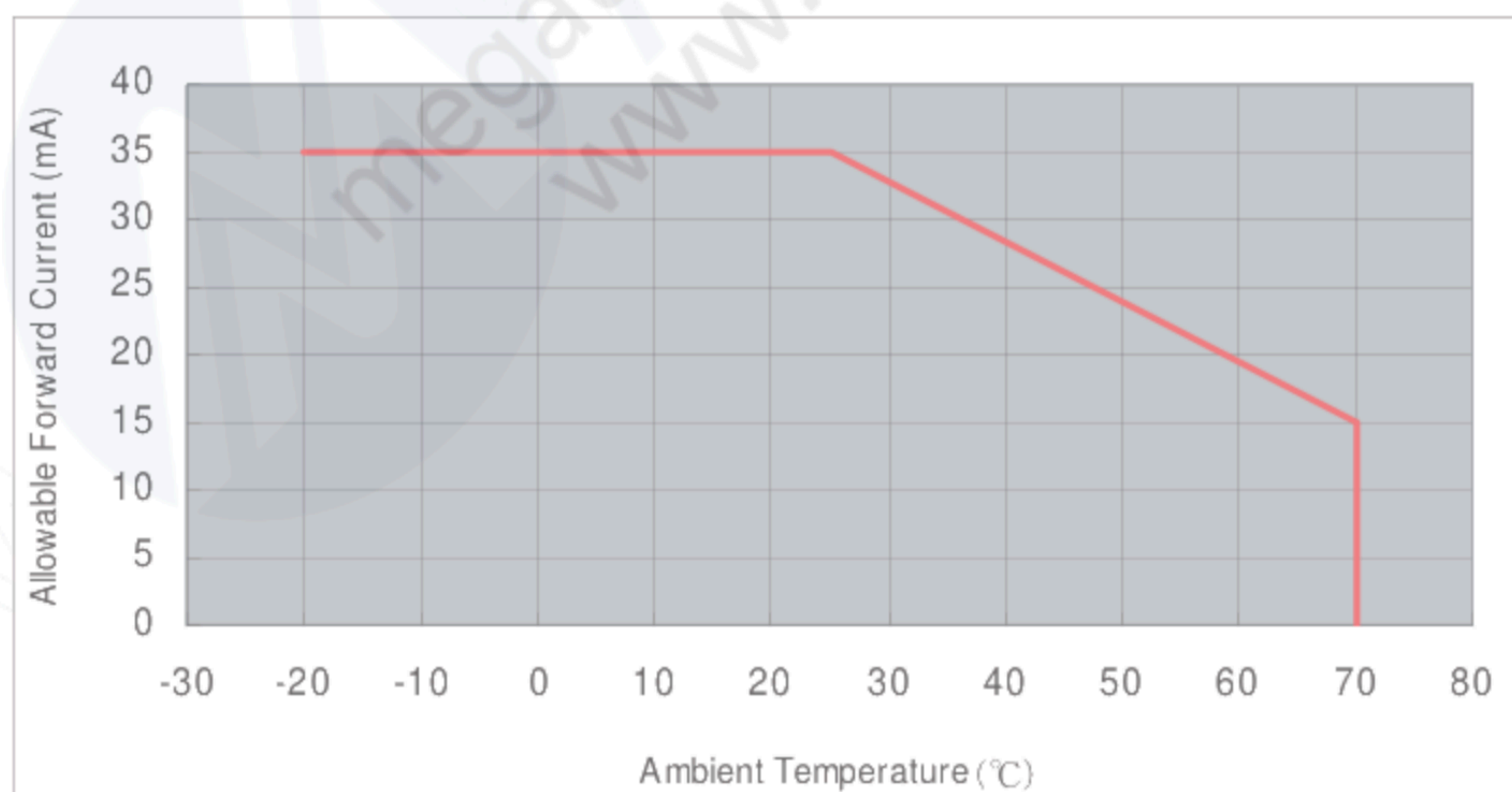

8. Characteristics

8.1 DC Characteristics

8.1.1 Display Module

(Unless otherwise noted, Ta=25°C, VDD=3.0V, VCCIO=1.8V, VSS=0V)

Item	Symbol	Condition	Rating			Unit	Applicable terminal
			MIN	TYP	MAX		
Input Signal Voltage	VIH	VCCIO=1.7-2.5V	0.7×VCCIO	--	VCCIO	V	CLK, VSYNC, HSYNC, DE, D[05:00], D[15:10], D[25:20], STBYB, RESETB
	VIL		0	--	0.3×VCCIO	V	
Operating Current	IDD	fCLK=19.8MHz	--	12.0	24.0	mA	VDD
	ICCIO	Color bar display	--	66.0	132.0	μA	VCCIO
Stand-by Current	IDDS	Other input with constant voltage	--	5.0	20.0	μA	VDD
	ICCIOS		--	--	1.0	μA	VCCIO

8.1.2 Backlight

Item	Symbol	Condition	Rating			Unit	Applicable terminal
			MIN	TYP	MAX		
Forward current	IL25	Ta=25 °C	—	8.0	35.0	mA	BLH — BLL
	IL70	Ta=70 °C	—	—	15.0	mA	
Forward voltage (Reference value)	VL	Ta=25 °C IL=8.0mA	—	16.1	17.0	V	
Estimated Life of LED	LL	Ta=25 °C IL=8.0mA Note	—	(50,000)	—	hr	

Note: - The lifetime of the LED is defined as a period till the brightness of the LED decreases to the half of its initial value.

- This figure is given as a reference purpose only, and not as a guarantee.
 - This figure is estimated for an LED operating alone.
- As the performance of an LED may differ when assembled as a monitor together with a TFT panel due to different environmental temperature.
- Estimated lifetime could vary on a different temperature and usually higher temperature could reduce the life significantly.

8.2 AC Characteristics

(Unless otherwise noted, Ta=25°C, VDD=3.0V, VCCIO=1.8V, VSS=0V)

Item	Symbol	Condition	Rating			Unit	Applicable terminal
			MIN	TYP	MAX		
CLK frequency	fCLK		18	19.8	27	MHz	CLK
CLK Low period	tw1L	0.3×VCCIO or less	10	--	--	ns	
CLK High period	tw1H	0.7×VCCIO or more	10	--	--	ns	
Setup time	tsp		10	--	--	ns	CLK, VSYNC, HSYNC, DE,
Hold time	thd		10	--	--	ns	D[05:00], D[15:10] D[25:20]

Switching Waveform Characteristics

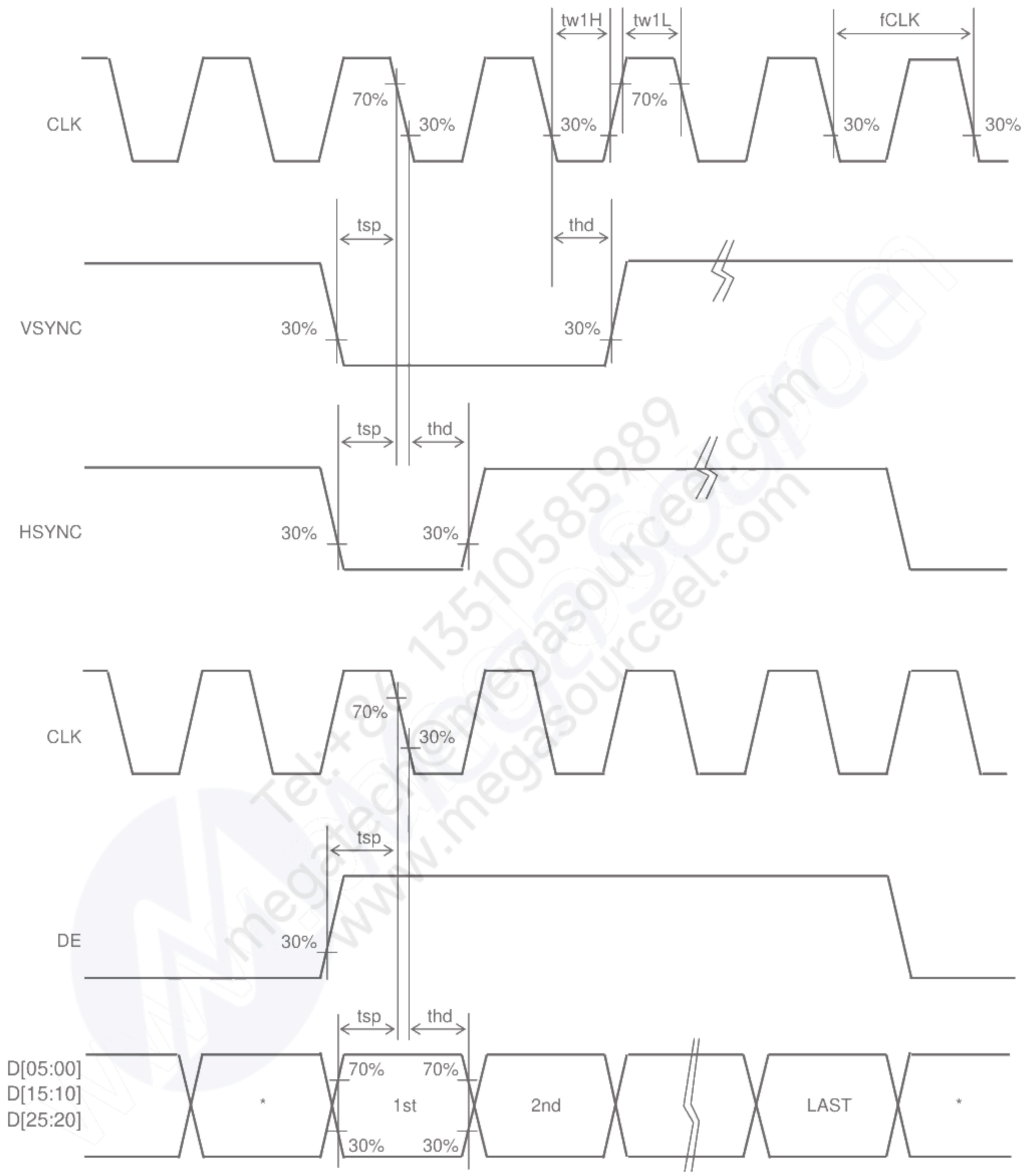

*:INVALID

8.3 Input Timing Characteristics

Item	Symbol	Rating			Unit	Applicable terminal
		MIN	TYP	MAX		
CLK Frequency	fCLK	18	19.8	27	MHz	CLK
VSYNC Frequency	Note fVSYNC	54	60	66	Hz	VSYNC
VSYNC Cycle	tv	646	650	700	H	VSYNC,HSYNC
VSYNC Pulse Width	tw4H	2	3	50	H	
Vertical Back Porch	tvb	2	3	50	H	VSYNC,HSYNC,DE,
Vertical Front Porch	tvf	2	4	50	H	D[05:00],D[15:10],D[25:20]
Vertical Display Period	tvdp	--	640	--	H	
HSYNC frequency	fHSYNC	--	39.0	50.0	kHz	HSYNC
HSYNC Cycle	th	504	508	630	CLK	CLK,HSYNC
HSYNC Pulse Width	tw5H	5	10	140	CLK	
Horizontal Back Porch	thb	5	10	140	CLK	CLK,HSYNC,DE,
Horizontal Front Porch	thf	5	8	140	CLK	D[05:00],D[15:10],D[25:20]
Horizontal data start Point	tw5H+thb	19	--	145	CLK	
Horizontal Blanking Period	tw5H+thb+thf	24	--	150	CLK	
DE Pulse Width	tw6H	--	480	--	CLK	CLK,DE
Horizontal Display Period	thdp	--	480	--	CLK	CLK,DE, D[05:00],D[15:10],D[25:20]

Note: This is recommended spec to get high quality picture on display. It is customer's risk to use out of this frequency.

8.4 Driving Timing Chart

-Vertical Timing

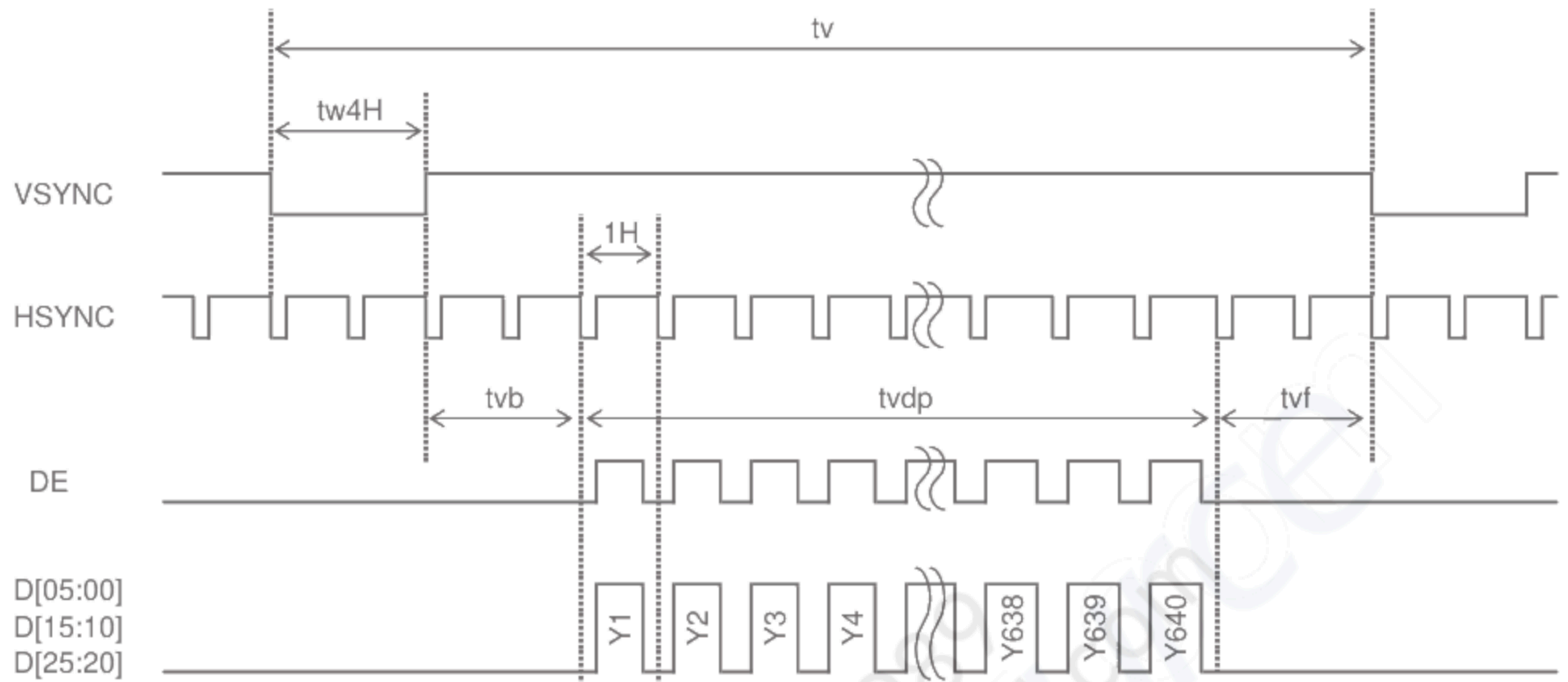

-Horizontal Timing

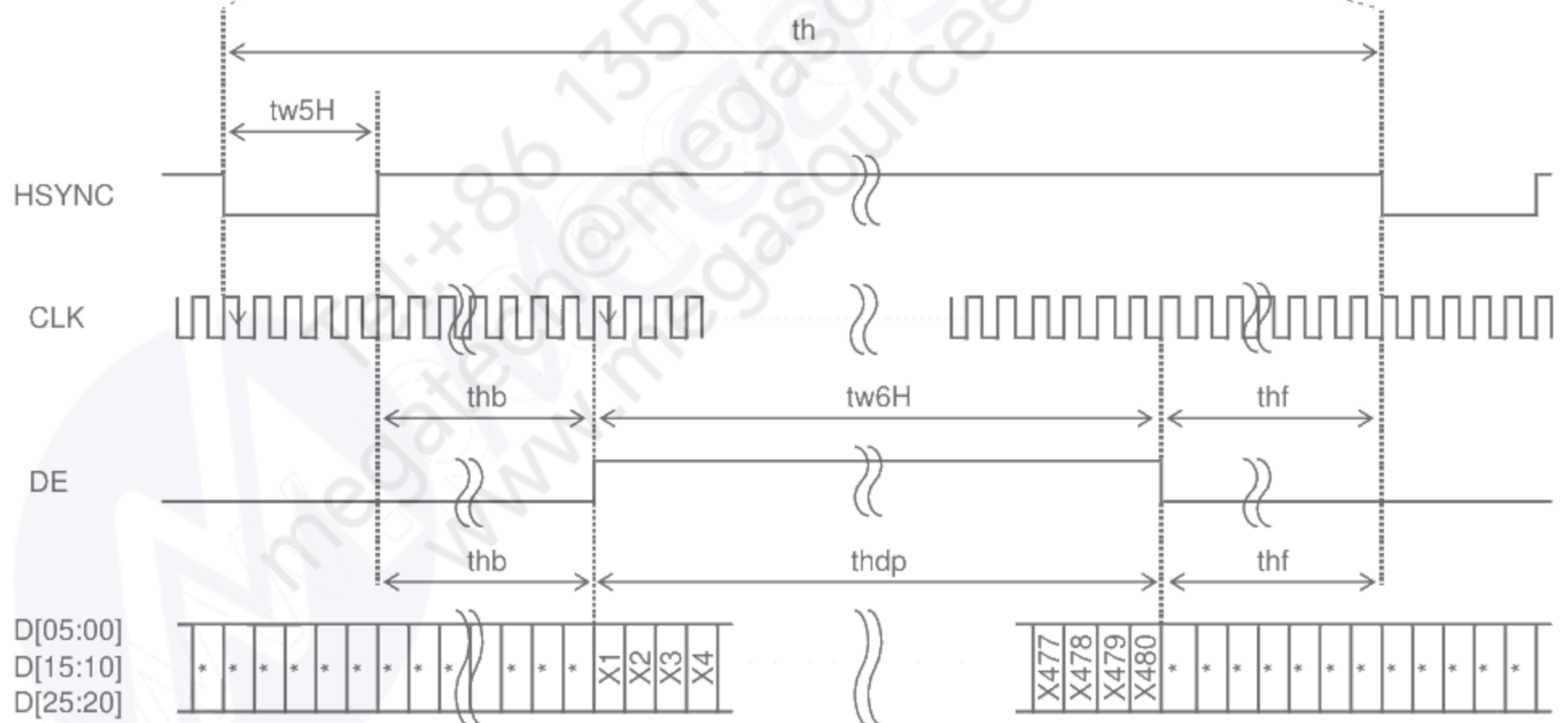

8.5 Example of Driving Timing Chart (fCLK=19.8MHz)

-Vertical Timing

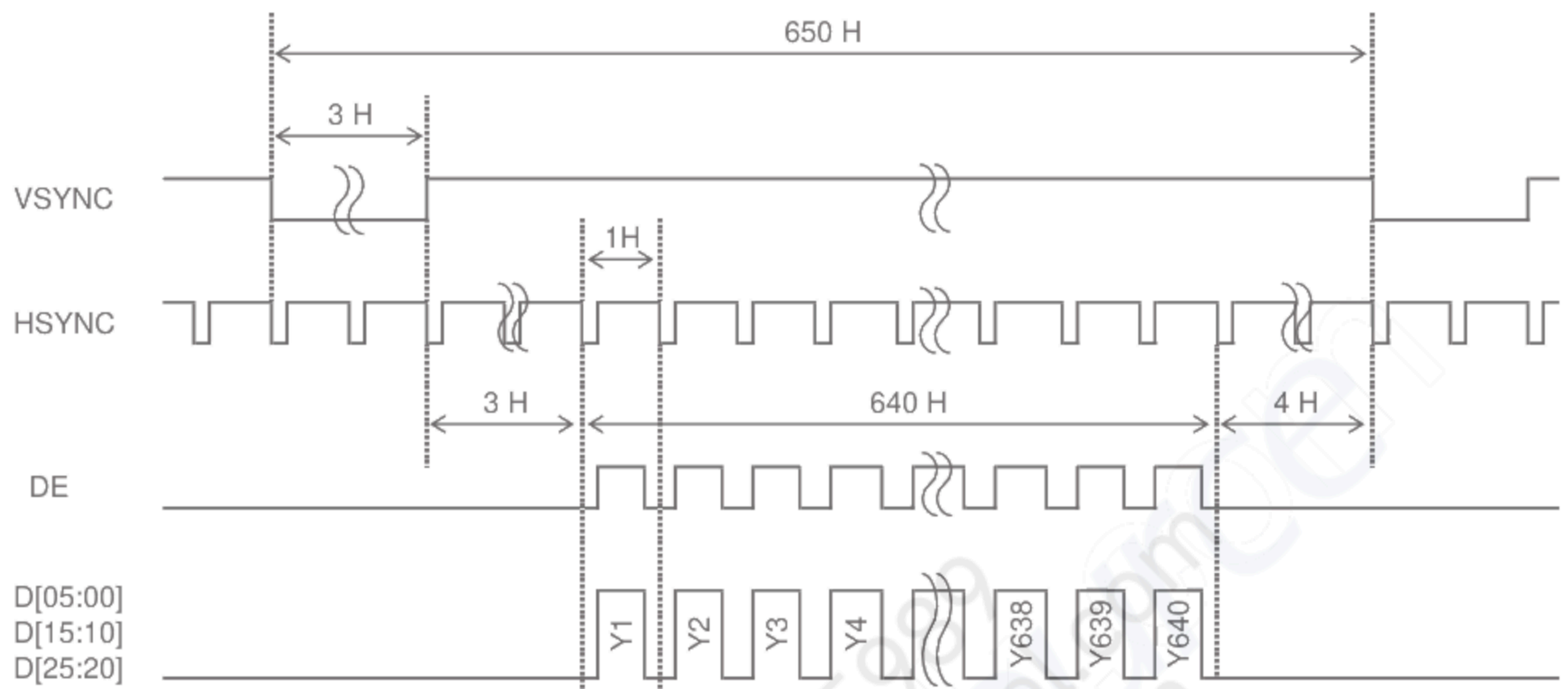

-Horizontal Timing

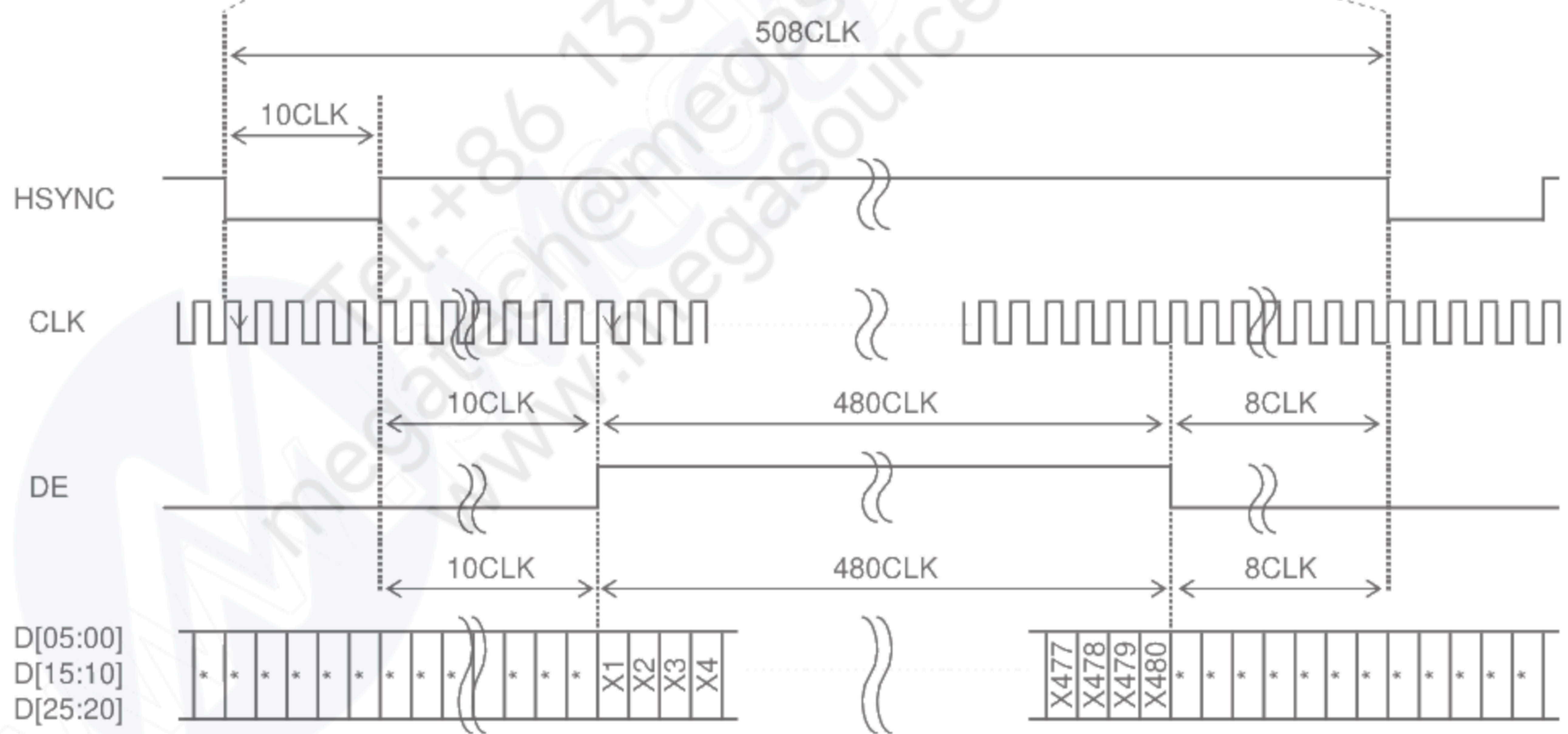

9 Power ON/OFF sequence

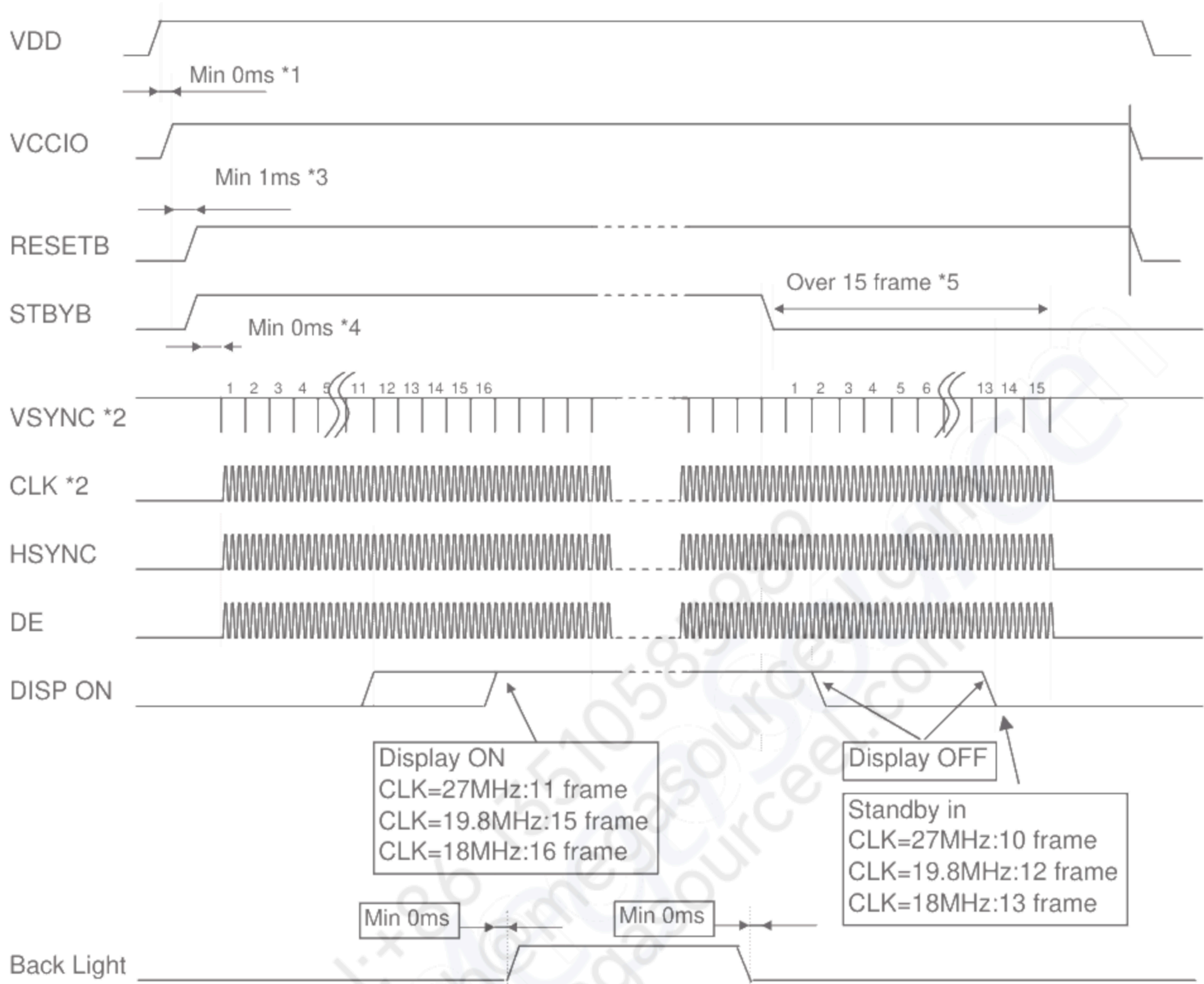

*1 Please start up VDD and VCCIO at the same time or in order of VDD --> VCCIO.

*2 CLK is used for Gate array CLK on FPC.
 VSYNC is used for Gate array's inside counter.
 It becomes the operation after CLK ,VSYNC input.

*3 After the power supply, Please execute RESETB.

*4 There is no regulations at time until each signal is supplied from RESETB"H"
 But meanwhile, It is necessary to fix each signal to "H"or"L".

*5 It is necessary to supply VSYNC and CLK for 15 frames or more from STBYB "L" to turning off the power supply without leaving the afterimage.

10. Characteristics

10.1 Optical Characteristics

< Measurement Condition >

Measuring instruments: CS1000 (KONICA MINOLTA) , LCD7200(OTSUKA ELECTRONICS) ,
EZcontrast160D (ELDIM)

Driving condition: Refer to typical rating of the section "Recommended Operating Conditions"
Optimized VCOMDC

Backlight: IL=8.0mA

Measured temperature: Ta=25° C

Item	Symbol	Condition	MIN	TYP	MAX	Unit	Note No.	Remark
Response time	Rise time	TON	[Data]= 00h→3Fh	—	—	60	ms	1 ※
	Fall time	TOFF	[Data]= 3Fh→00h	—	—	40	ms	
Contrast ratio	Backlight ON	CR	[Data]= 3Fh / 00h	360	600	—		2
	Backlight OFF			—	5.5	—		
Viewing angle	Left	θL	[Data]= 00h / 3Fh CR ≥ 10	80	—	—	deg	3 ※
	Right	θR		80	—	—	deg	
	Up	φU		80	—	—	deg	
	Down	φD		80	—	—	deg	
White Chromaticity	x	[Data]=3Fh	White chromaticity range				4	
	y							
Burn-in			No noticeable burn-in image should be observed after 2 hours of window pattern display.				5	
Center brightness		[Data]=3Fh	200	320	—	cd/m ²	6	
Brightness distribution		[Data]=3Fh	70	—	—	%	7	

* Note number 1 to 7: Refer to the APPENDIX of "Reference Method for Measuring Optical Characteristics".

※ Measured in the form of LCD module.

White V-T Curve

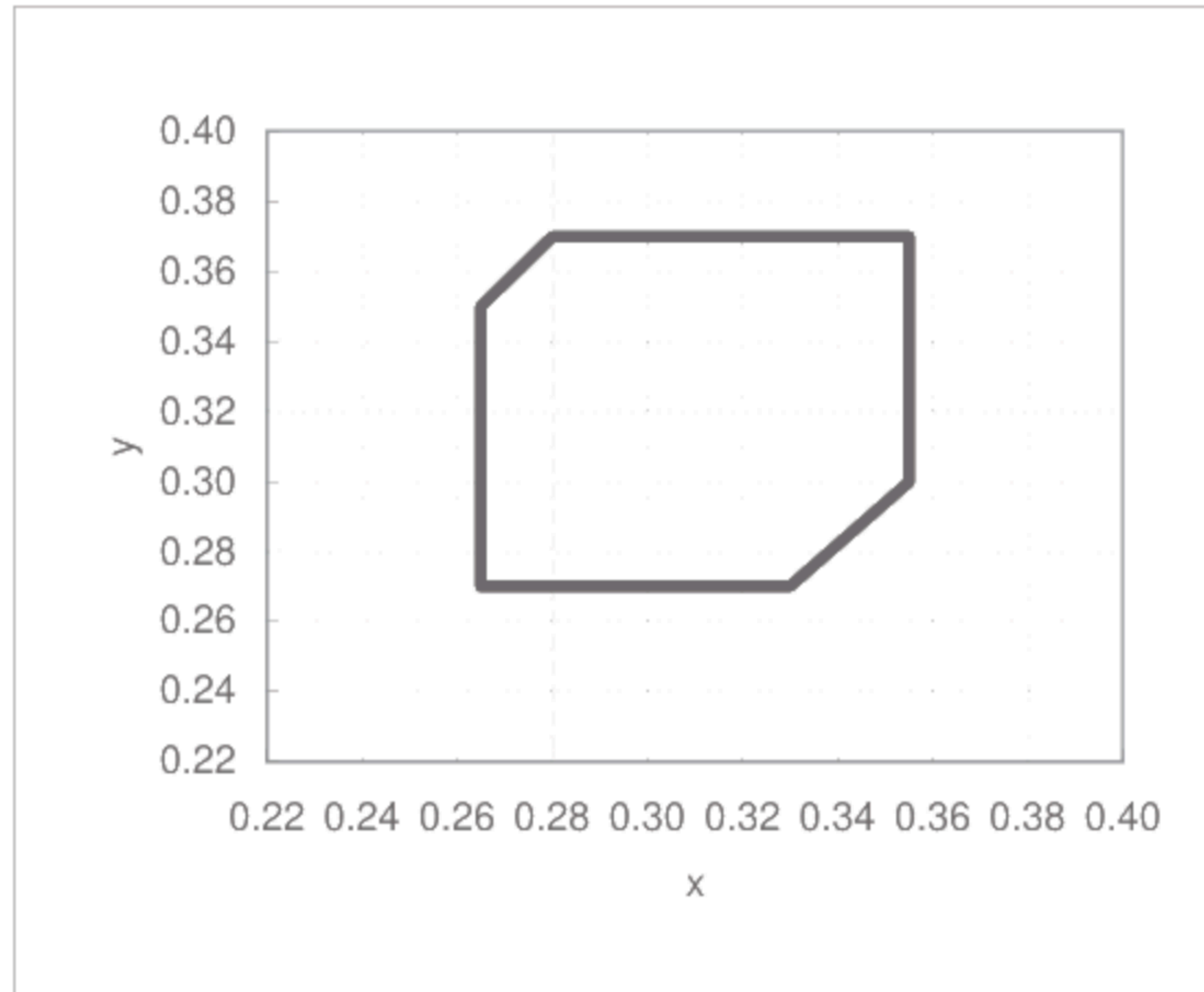

White Chromaticity Range

【White Chromaticity Range】

x	y
0.28	0.37
0.36	0.37
0.36	0.30
0.33	0.27
0.27	0.27
0.27	0.35

10.2 Temperature Characteristics

< Measurement Condition >

Measuring instruments: CS1000 (KONICA MINOLTA) , LCD7200(OTSUKA ELECTRONICS)

Driving condition: Refer to typical rating of the section "Recommended Operating Conditions"

Optimized VCOMDC

Backlight: IL=8.0mA

Item	Specification		Remark		
	Ta=-10° C	Ta=70° C			
Contrast ratio	CR	40 or more	40 or more	Backlight ON	
Response time	Rise time	TON	200 msec or less	30 msec or less	※
	Fall time	TOFF	300 msec or less	50 msec or less	※
Display Quality		No noticeable display defect or ununiformity should be observed.		Use the criteria for judgment specified in the section 11.	

※ Measured in the form of LCD module.

11. Criteria of Judgment

11.1 Defective Display and Screen Quality

Test Condition: Observed TFT-LCD monitor from front during operation with the following conditions
 Driving Signal Raster Patter (RGB, white, black)
 Signal condition [Data] = 00h, 25h, 3Fh (3steps)
 Observation distance 30 cm
 Illuminance 200 to 350 lx
 Backlight IL=8.0mA

Defect item		Defect content	Criteria	
Display Quality	Line defect	Black, white or color line, 3 or more neighboring defective dots	Not exists	
	Dot defect	Uneven brightness on dot-by-dot base due to defective TFT or CF, or dust is counted as dot defect (brighter dot, darker dot) High bright dot: Visible through 2% ND filter at [Data]=00h Low bright dot: Visible through 5% ND filter at [Data]=00h Dark dot: Appear dark through white display at [Data]=25h Invisible through 5% ND filter at [Data]=00h	Refer to table 1	
				ignored
Screen Quality	Dirt	Point-like uneven brightness (white stain, black stain etc)	Invisible through 1% ND filter	
	Foreign particle	Point-like	0.25mm < φ	N=0
			0.20mm < φ ≤ 0.25mm	N ≤ 2
		φ ≤ 0.20mm	Ignored	
	Liner	3.0mm < length and 0.08mm < width	N=0	
length ≤ 3.0mm or width ≤ 0.08mm		Ignored		
Others		Use boundary sample for judgment when necessary		

φ(mm): Average diameter = (major axis + minor axis)/2
 Permissible number: N

Table 1

Area	High bright dot	Low bright dot	Dark dot	Total	Criteria
A	0	2	2	3	Permissible distance between same color bright dots (includes neighboring dots): 3 mm or more
B	2	4	4	6	Permissible distance between same color high bright dots (includes neighboring dots): 5 mm or more
Total	2	4	4	7	

<Portrait model>

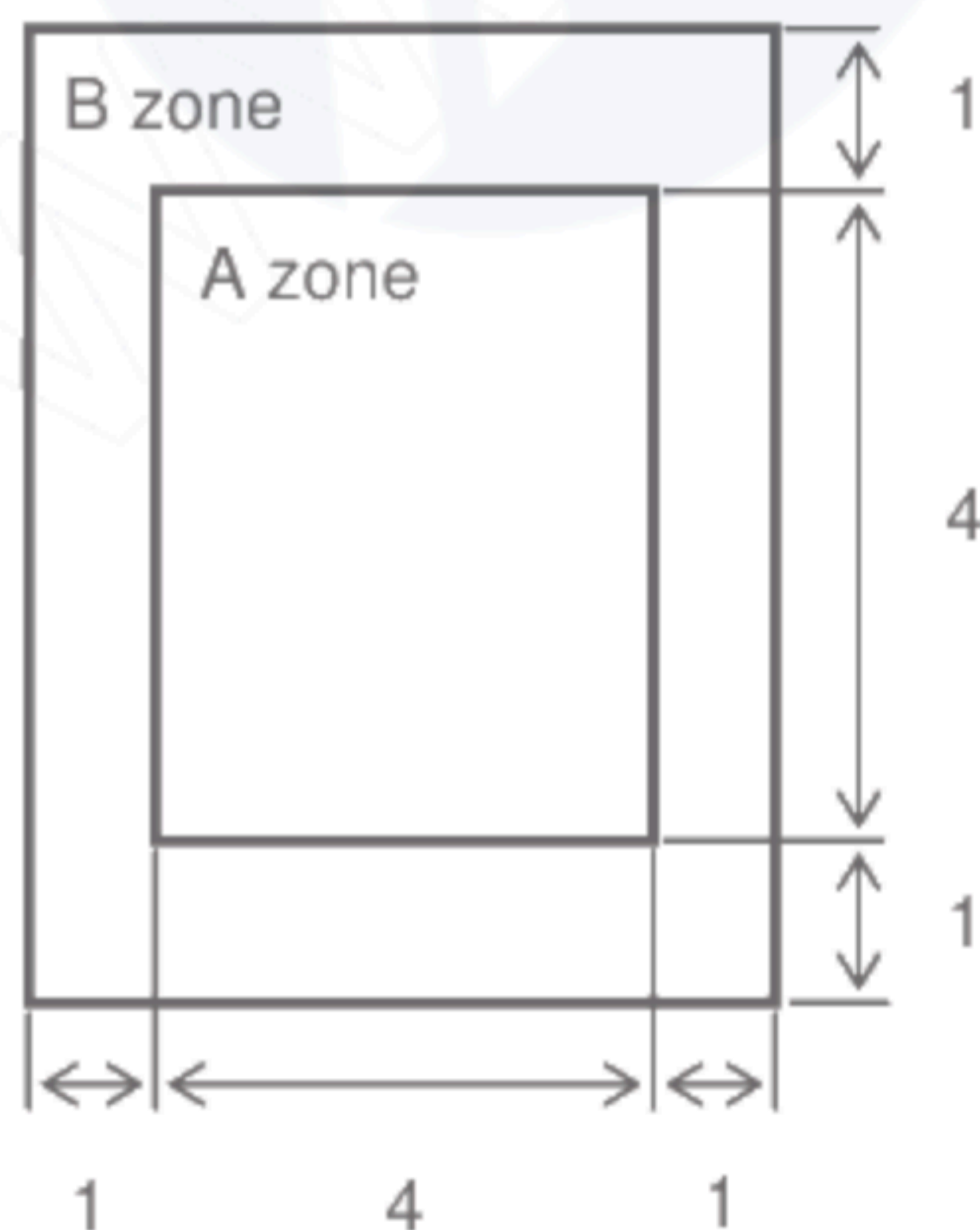

Division of A and B areas
 B area: Active area
 Dimensional ratio between A and B areas: 1: 4: 1 (Refer to the left figure)

11.2 Screen and Other Appearance

Testing conditions

Observation distance	30cm
Illuminance	1200~2000 lx

Item		Criteria	Remark
Polarizer	Flaw	Ignore invisible defect when the backlight is on.	Applicable area: Active area only (Refer to the section 3.2 "Outward form")
	Stain		
	Bubble		
	Dust		
	Dent		
S-case		No functional defect occurs	
FPC cable		No functional defect occurs	

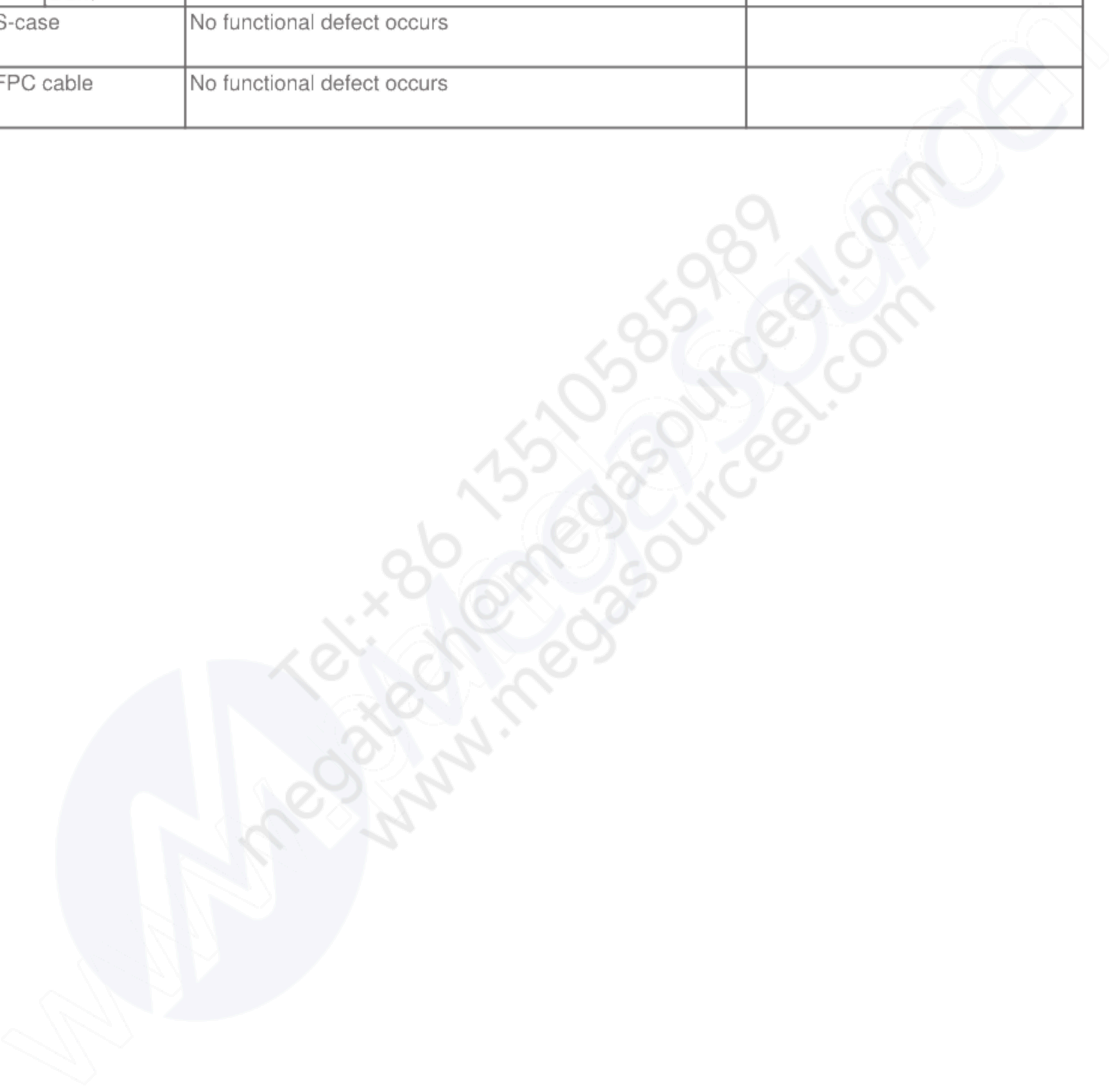

12. Reliability Test

Test item	Test condition	number of failures /number of examinations
Durability test	High temperature storage	Ta=80° C 240H 0/3
	Low temperature storage	Ta=-30° C 240H 0/3
	High temperature & high humidity storage	Ta=60° C, RH=90% non condensing ※ 0/3
	High temperature operation	Tp=70° C 240H 0/3
	Low temperature operation	Tp=-20° C 240H 0/3
	High temp & humid operation	Tp=40° C, RH=90% non condensing ※ 0/3
	Thermal shock storage	-30←→80° C(30min/30min) 100 cycles 0/3
Mechanical environmental test	Electrostatic discharge test (Non operation)	Confirms to EIAJ ED-4701/300 C=200pF,R=0Ω,V=±200V Each 3 times of discharge on and power supply and other terminals. 0/3
	Surface discharge test (Non operation)	C=250pF, R=100Ω, V=±12kV Each 5 times of discharge in both polarities on the center of screen with the case grounded. 0/3
	Vibration test	Total amplitude 1.5mm, f=10~55Hz, X,Y,Z directions for each 2 hours 0/3
	Impact test	Use ORTUS TECHNOLOGY original jig (see next page)and make an impact with peak acceleration of 1000m/s ² for 6 msec with half sine-curve at 3 times to each X, Y, Z directions in conformance with JIS C 60068-2-27-2011. 0/3
Packing test	Packing vibration-proof test	Acceleration of 19.6m/s ² with frequency of 10→55→10Hz, X,Y, Zdirection for each 30 minutes 0/1 Packing
	Packing drop test	Drop from 75cm high. 1 time to each 6 surfaces, 3 edges, 1 corner 0/1 Packing

Note:Ta=ambient temperature Tp=Panel temperature

※ The profile of high temperature/humidity storage and High Temperature/humidity operation (Pure water of over 10MΩ·cm shall be used.)

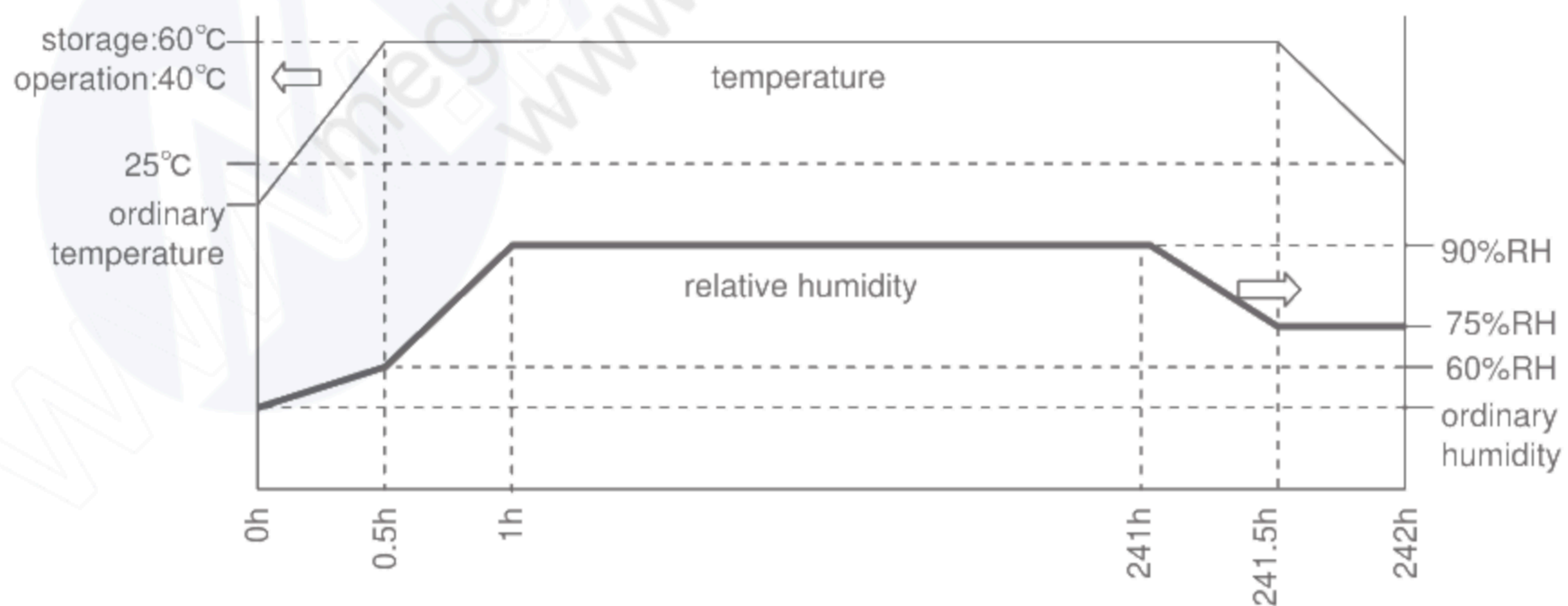
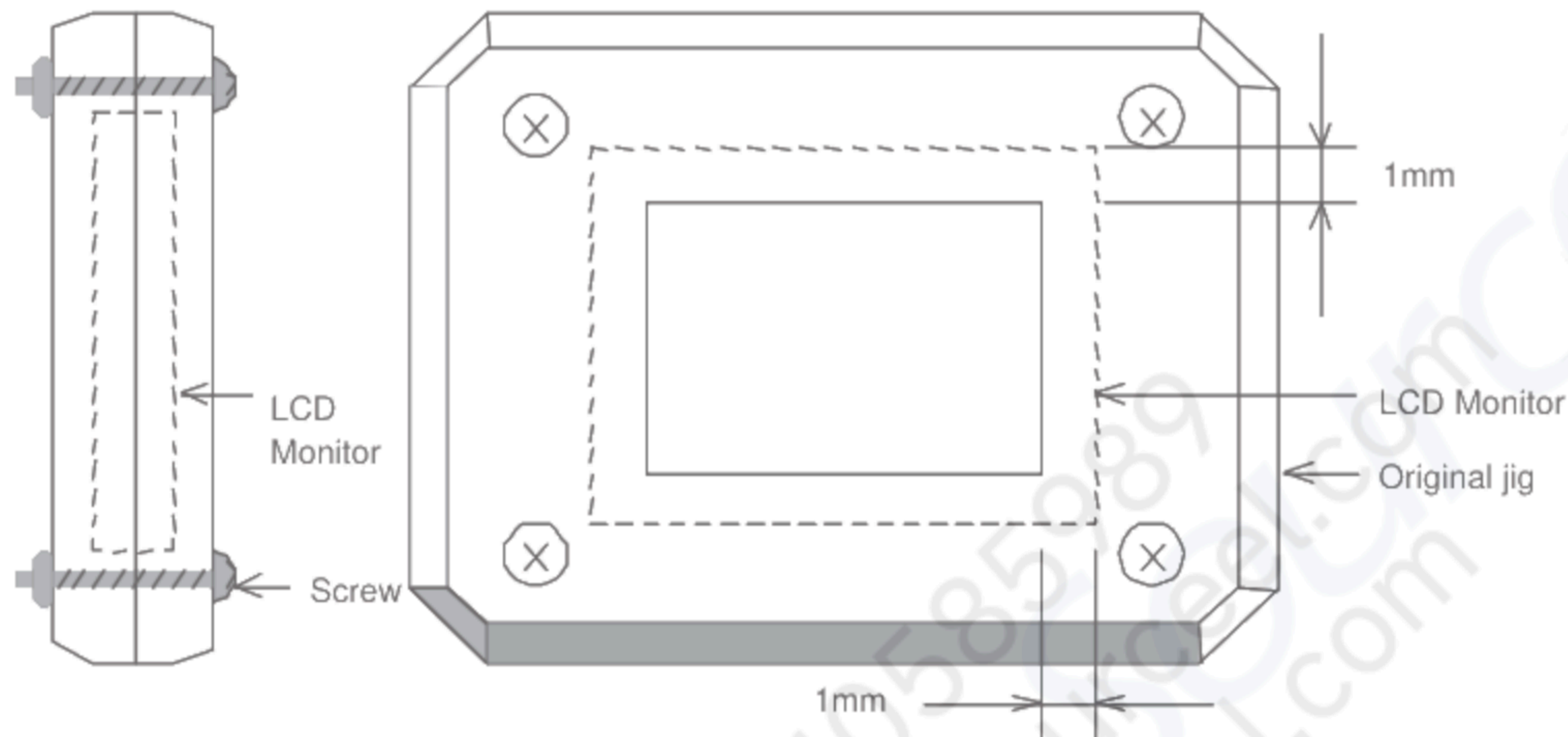

Table2.Reliability Criteria

Measure the parameters after leaving the monitor at the ordinary temperature for 24 hours or more after the test completion.

item	Standard	Remarks
Display quality	No visible abnormality shall be seen.	
Contrast ratio	40 or more	Backlight ON

ORTUS TECHNOLOGY Original Jig



13. Packing Specifications

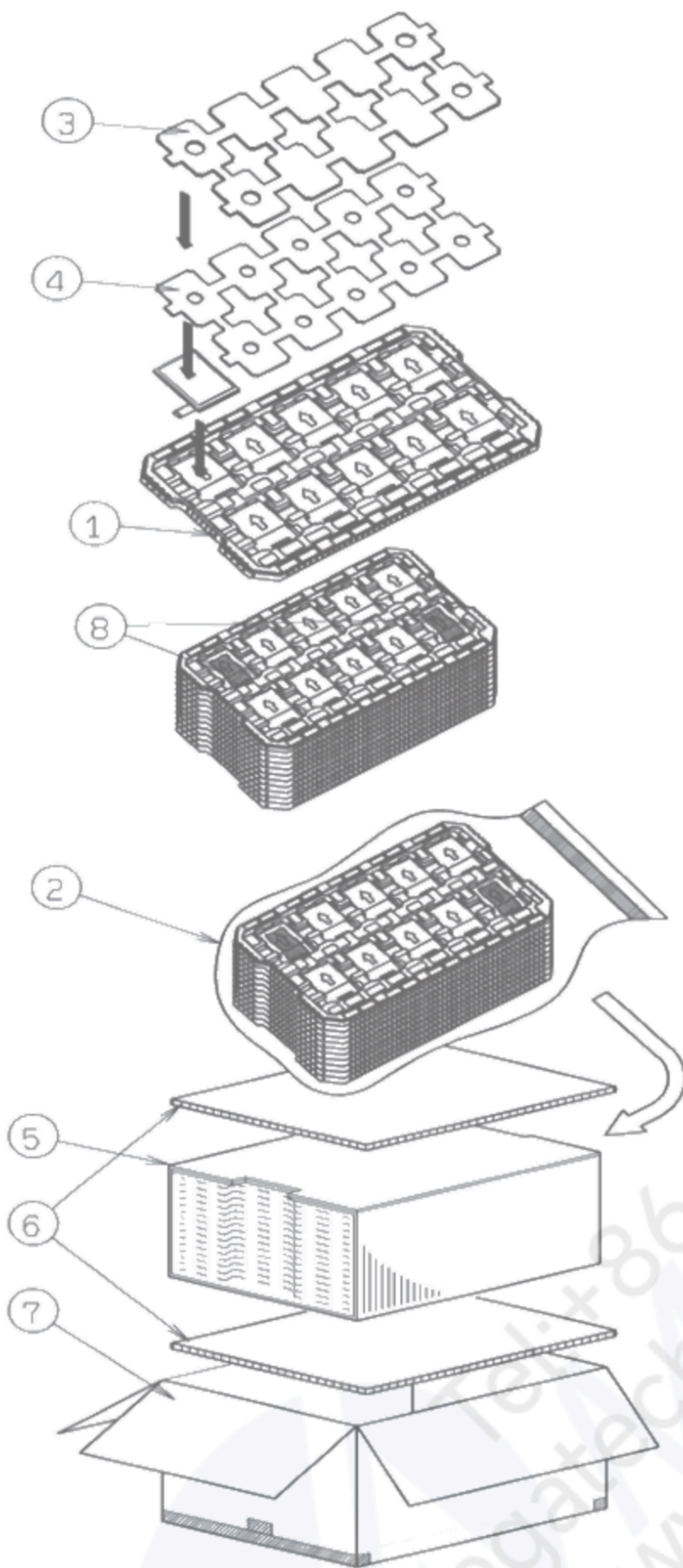

Step 1. Each product is to be placed in one of the cut-outs of the tray with the display surface facing upward. (10products per tray)
Put the Form Sheet A and Form Sheet C.

Step 2. The Foam sheet is to be put on the products in the tray.
Each tray is to be piled up in same orientation and the trays be in a stack of 10.

Step 3. One empty tray is to be put on the top of stack of 10 trays.
2 packs of moisture absorbers are to be placed on the top tray as shown in the drawing. Put piled trays into a sealing bag.
Vacuum and seal the sealing bag with the vacuum sealing machine.

Step 4. The stack of trays in the plastic back is to be inserted into a inner carton.

Step 5. A corrugated board is to be placed on the top and on the bottom of the inner carton.
The two corrugated boards and the inner carton is to be inserted into an outer carton.

Step 6. The outer carton needs to sealed with packing tape as shown in the drawing.
The model number, quantity of products, and shipping date are to be printed on the outer carton.
If necessary, shipping labels or impression markings are to be put on the outer carton.

Step 7. The outer carton is to be inserted into a extra outer carton with same direction.
The extra outer carton needs to sealed with packing tape as shown in the drawing.

Step 8. The model number, quantity of products, and shipping date are to be printed on the extra outer carton.
If necessary, shipping labels or impression markings are to be put on the extra outer carton.

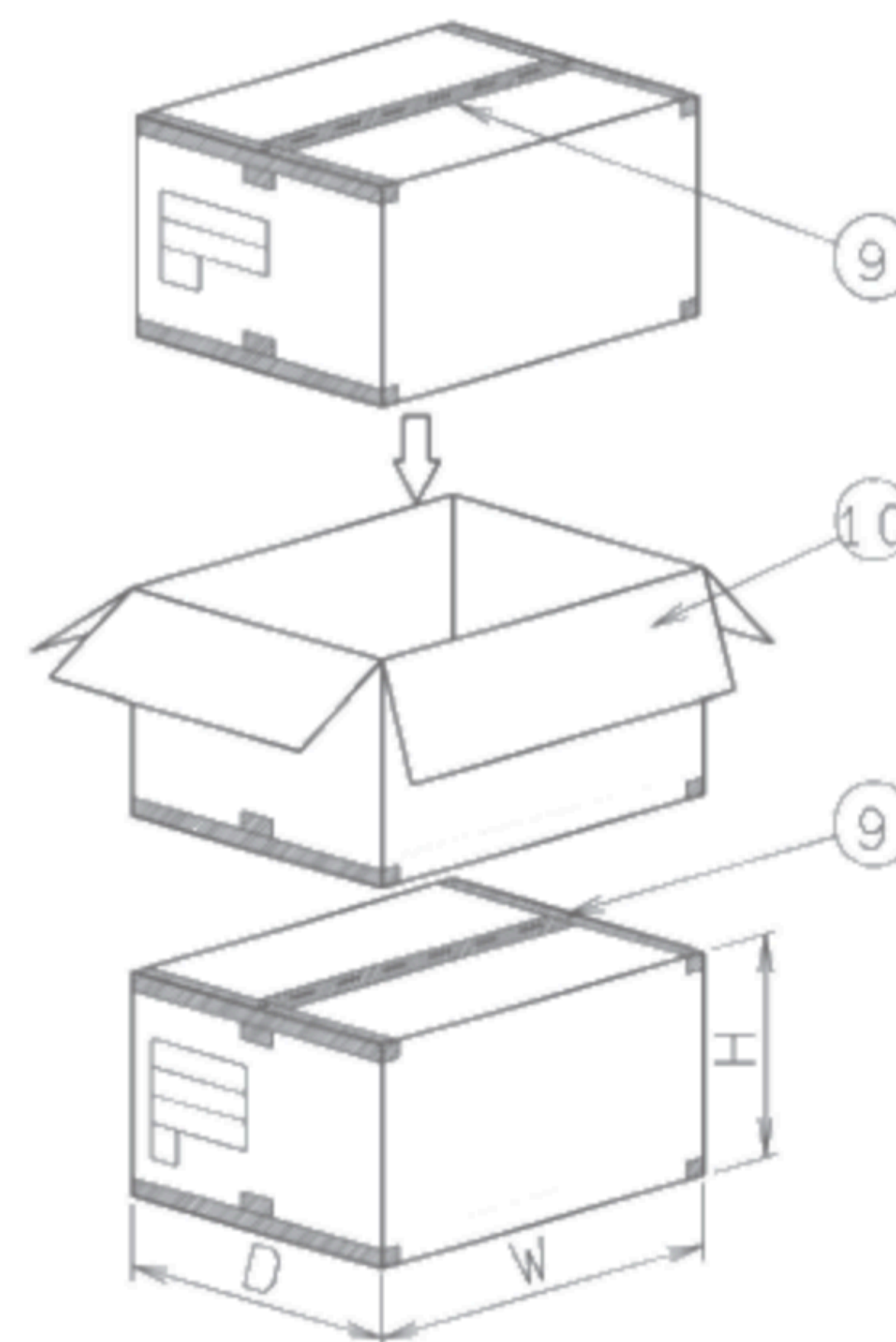

Remark: The return of packing materials is not required.

Packing item name	Specs., Material
① Tray	A-PET
② Sealing bag	
③ Foam sheet A	Anti-static polyethylene
④ Foam sheet C	Anti-static polyethylene
⑤ Inner carton	Corrugated cardboard
⑥ Inner board	Corrugated cardboard
⑦ Outer carton	Corrugated cardboard
⑧ Drier	Moisture absorber
⑨ Packing tape	
⑩ Extra outer carton	Corrugated cardboard

Dimension of extra outer carton	
D : Approx.	(338mm)
W : Approx.	(549mm)
H : Approx.	(198mm)
Quantity of products packed in one carton:	100
Gross weight : Approx.	6.8kg

14. Handling Instruction

14.1 Cautions for Handling LCD panels

**Caution**

- (1) Do not make an impact on the LCD panel glass because it may break and you may get injured from it.
- (2) If the glass breaks, do not touch it with bare hands.
(Fragment of broken glass may stick you or you cut yourself on it.)
- (3) If you get injured, receive adequate first aid and consult a medial doctor.
- (4) Do not let liquid crystal get into your mouth.
(If the LCD panel glass breaks, try not let liquid crystal get into your mouth even toxic property of liquid crystal has not been confirmed.)
- (5) If liquid crystal adheres, rinse it out thoroughly.
(If liquid crystal adheres to your cloth or skin, wipe it off with rubbing alcohol or wash it thoroughly with soap. If liquid crystal gets into eyes, rinse it with clean water for at least 15 minutes and consult an eye doctor.)
- (6) If you scrap this products, follow a disposal standard of industrial waste that is legally valid in the community, country or territory where you reside.
- (7) Do not connect or disconnect this product while its application products is powered on.
- (8) Do not attempt to disassemble or modify this product as it is precision component.
- (9) If a part of soldering part has been exposed, and avoid contact (short-circuit) with a metallic part of the case etc. about FPC of this model, please.
Please insulate it with the insulating tape etc. if necessary.
The defective operation is caused, and there is a possibility to generation of heat and the ignition.
- (10) Since excess current protection circuit is not built in this TFT module, there is the possibility that LCD module or peripheral circuit become feverish and burned in case abnormal operation is generated.
We recommend you to add excess current protection circuit to power supply.
- (11) The devices on the FPC are damageable to electrostatic discharge, because the terminals of the devices are exposed.
Wear grounded wrist-straps and use electrostatic neutralization blowers to prevent static charge and discharge when handling the TFT monitors.
Designate an appropriate operating area, and set equipment, tools, and machines properly when handling this product.

Caution This mark is used to indicate a precaution or an instruction which, if not correctly observed, may result in bodily injury, or material damages alone.

14.2 Precautions for Handling

- 1) Wear finger tips at incoming inspection and for handling the TFT monitors to keep display quality and keep the working area clean.
Do not touch the surface of the monitor as it is easily scratched.
- 2) Wear grounded wrist-straps and use electrostatic neutralization blowers to prevent static charge and discharge when handling the TFT monitors as the LED in this TFT monitors is damageable to electrostatic discharge. Designate an appropriate operating area, and set equipment, tools, and machines properly when handling this product.
- 3) Avoid strong mechanical shock including knocking, hitting or dropping to the TFT monitors for protecting their glass parts. Do not use the TFT monitors that have been experienced dropping or strong mechanical shock.
- 4) Do not use or storage the TFT monitors at high temperature and high humidity environment. Particularly, never use or storage the TFT monitors at a location where condensation builds up.
- 5) Avoid using and storing TFT monitors at a location where they are exposed to direct sunlight or ultraviolet rays to prevent the LCD panels from deterioration by ultraviolet rays.
- 6) Do not stain or damage the contacts of the FPC cable .
FPC cable needs to be inserted until it can reach to the end of connector slot.
During insertion, make sure to keep the cable in a horizontal position to avoid an oblique insertion.
Otherwise, it may cause poor contact or deteriorate reliability of the FPC cable.
- 7) The FPC cable is a design very weak to the bend and the pull as it is fixed with the tape.
Do not bend or pull the FPC cable or carry the TFT monitor by holding the FPC cable.
- 8) Peel off the protective film on the TFT monitors during mounting process.
Refer to the section 14.5 on how to peel off the protective film.
We are not responsible for electrostatic discharge failures or other defects occur when peeling off the protective film.

14.3 Precautions for Operation

- 1) Since this TFT monitors are not equipped with light shielding for the driver IC, do not expose the driver IC to strong lights during operation as it may cause functional failures.
- 2) In case of powering up or powering off this LCD module, be sure to comply the sequence as instructed in this specification.
- 3) Do not plug in or out the FPC cable while power supply is switch on.
Plug the FPC cable in and out while power supply is switched off.
- 4) Do not operate the TFT monitors in the strong magnetic field. It may break the TFT monitors.
- 5) Do not display a fixed image on the screen for a long time.
Use a screen-saver or other measures to avoid a fixed image displayed on the screen for a long time.
Otherwise, it may cause burn-in image on the screen due the characteristics of liquid crystal.

14.4 Storage Condition for Shipping Cartons

Storage environment

- Temperature 0 to 40° C
- Humidity 60%RH or less
No-condensing occurs under low temperature with high humidity condition.
- Atmosphere No poisonous gas that can erode electronic components and/or wiring materials should be detected.
- Time period 3 months
- Unpacking To prevent damages caused by static electricity, anti-static precautionary measures (e.g. earthing, anti-static mat) should be implemented.
- Maximum piling up 7 cartons

14.5 Precautions for Peeling off the Protective film

The followings work environment and work method are recommended to prevent the TFT monitors from static damage or adhesion of dust when peeling off the protective films.

A) Work Environment

- a) Humidity: 50 to 70 %RH, Temperature 15 to 27° C
- b) Operators should wear conductive shoes, conductive clothes, conductive finger tips and grounded wrist-straps. Anti-static treatment should be implemented to work area's floor.
- c) Use a room shielded against outside dust with sticky floor mat laid at the entrance to eliminate dirt.

B) Work Method

The following procedures should taken to prevent the driver ICs from charging and discharging.

- a) Use an electrostatic neutralization blower to blow air on the TFT monitors to its lower left when the FPC cable facing to the leftside.
Optimize direction of the blowing air and the distance between the TFT monitors and the electrostatic neutralization blower.
- b) Put an adhesive tape (Scotch tape, etc) at the lower left corner area of the protective film to prevent scratch on surface of TFT monitors.
- c) Peel off the adhesive tape slowly (spending more than 2 secs to complete) by pulling it to opposite direction.

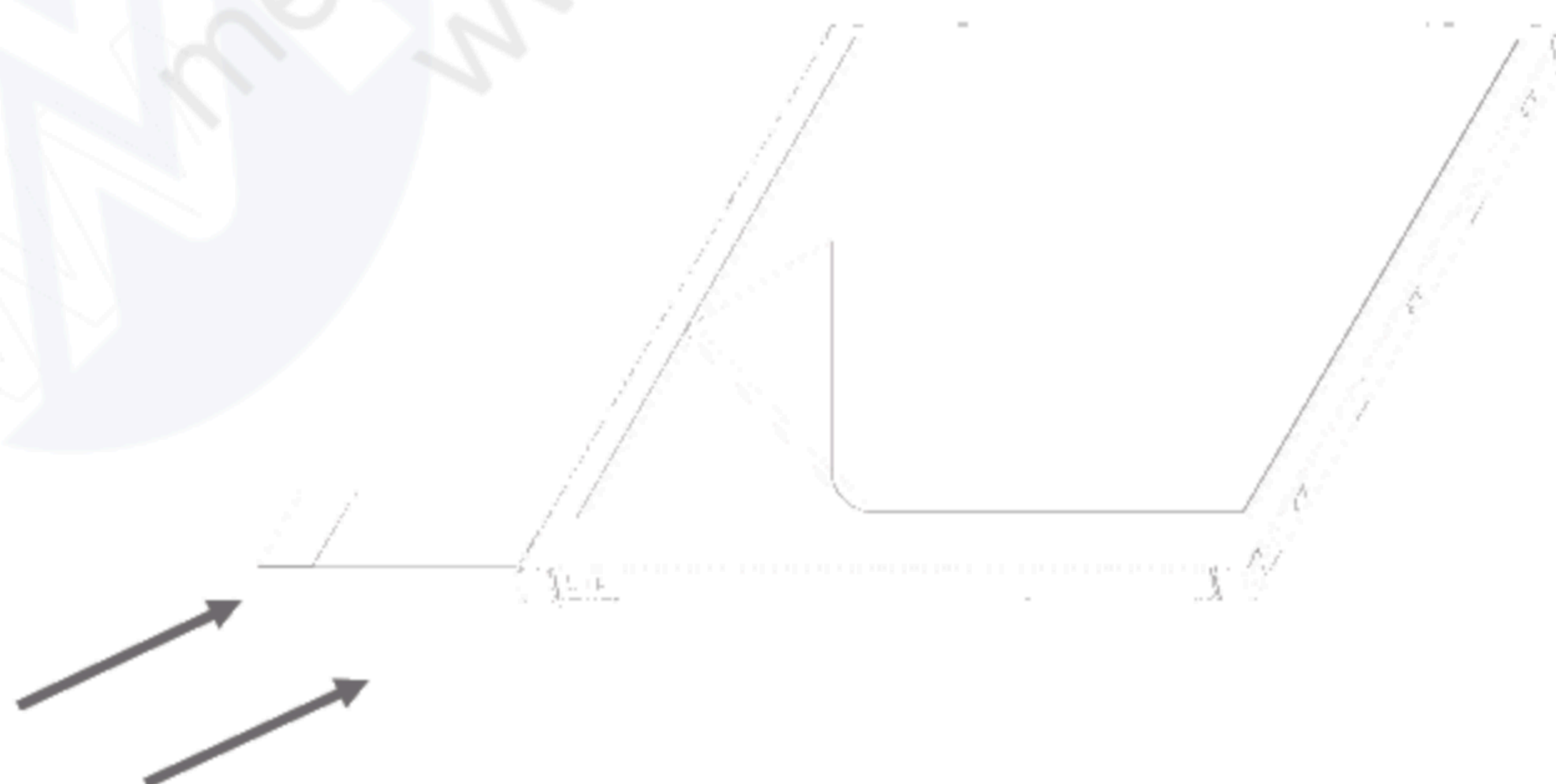

Direction of blowing air
(Optimize air direction and the distance)

Measurement Condition (Contrast ratio Backlight OFF only)

Measuring instruments: LCD7200(OTSUKA ELECTRONICS), Ring Light(40,000 lx, $\phi 58$)

Driving condition: Refer to typical rating of the section "Recommended Operating Conditions"

Measured temperature: 25°C unless specified

Measurement system: See the chart below.

Measurement point: At the center of the screen.

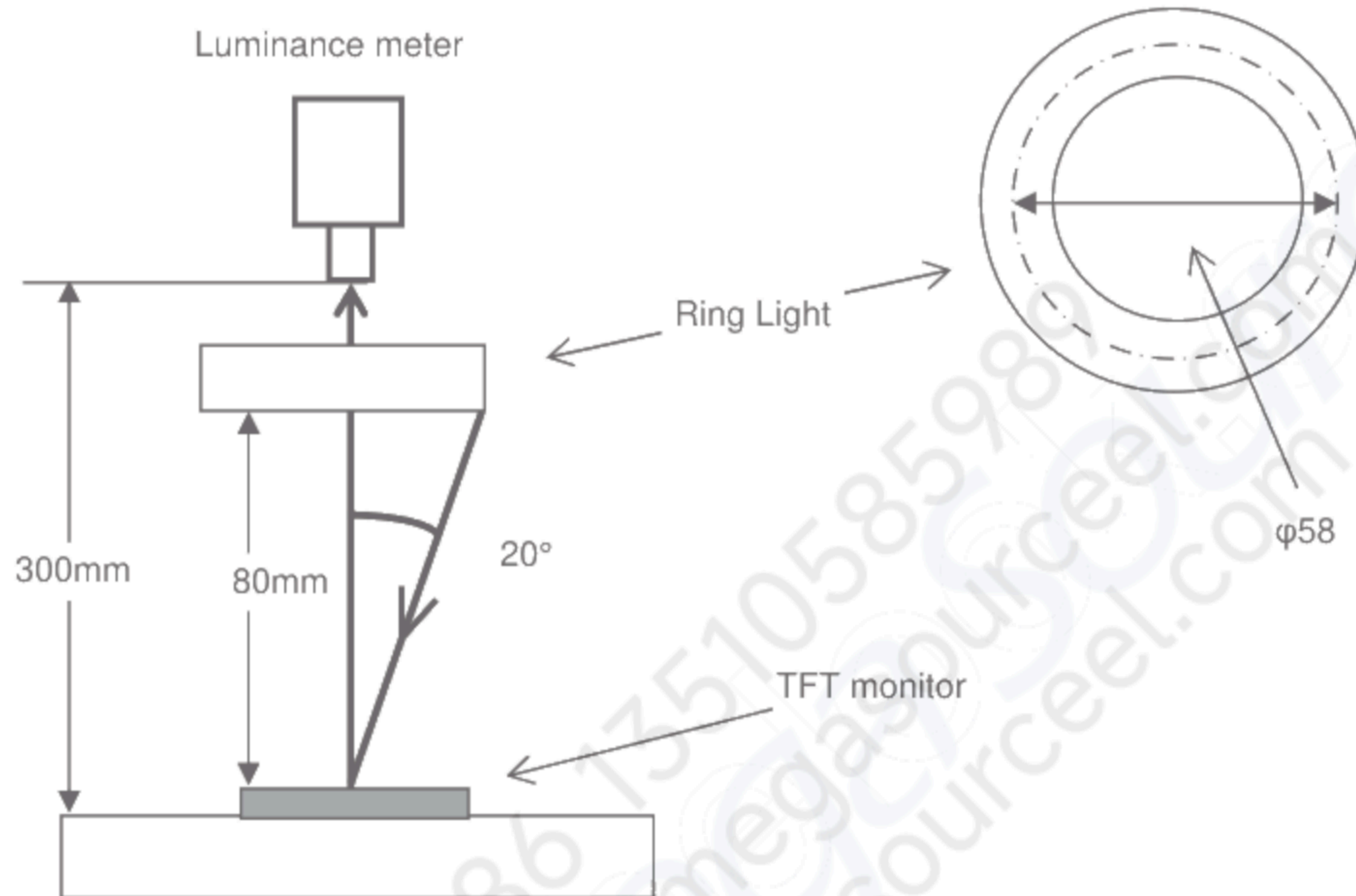

2. Test Method

Notice	Item	Test method	Measuring instrument	Remark
1	Response time	<p>Measure output signal waveform by the luminance meter when raster of window pattern is changed from white to black and from black to white.</p> <p style="text-align: center;">Black White Black</p> <p>White brightness</p> <p>100%</p> <p>90%</p> <p>10%</p> <p>0%</p> <p>Black brightness</p> <p>TON</p> <p>TOFF</p>	LCD7200	<p>Black display [Data]=00h</p> <p>White display [Data]=3Fh</p> <p>TON</p> <p>Rise time</p> <p>TOFF</p> <p>Fall time</p>
2	Contrast ratio	<p>Measure maximum luminance Y1([Data]=3Fh) and minimum luminance Y2([Data]=00h) at the center of the screen by displaying raster or window pattern. Then calculate the ratio between these two values.</p> <p style="text-align: center;">Contrast ratio = Y1/Y2</p> <p style="text-align: center;">Diameter of measuring point: 8mmφ</p>	CS1000 LCD7200	Backlight ON Backlight OFF
3	Viewing angle Horizontalθ Verticalφ	Move the luminance meter from right to left and up and down and determine the angles where contrast ratio is 10.	EZcontrast160D	
4	White chromaticity	<p>Measure chromaticity coordinates x and y of CIE1931 colorimetric system at [Data] = 3Fh)</p> <p style="text-align: center;">Color matching function: 2°view</p>	CS1000	
5	Burn-in	Visually check burn-in image on the screen after 2 hours of "window display" ([Data]=00h/3Fh).		
6	Center brightness	Measure the brightness at the center of the screen.	CS1000	
7	Brightness distribution	<p>(Brightness distribution) = 100 x B/A %</p> <p>A : max. brightness of the 9 points</p> <p>B : min. brightness of the 9 points</p>	CS1000	