

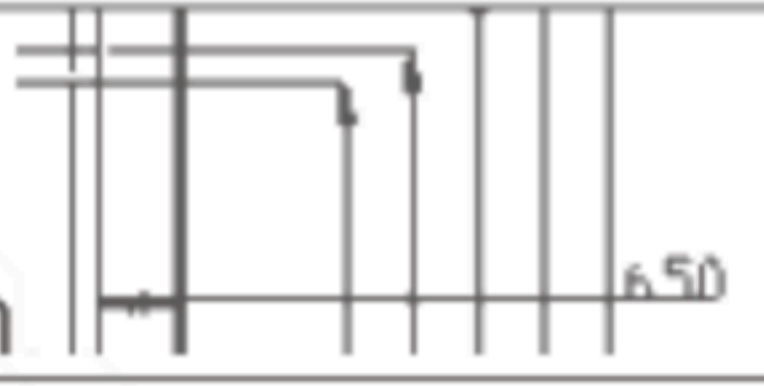

## Contents

<b>1. Operating Precautions</b> .....	<b>4</b>
<b>2. General Description</b> .....	<b>5</b>
2.1 Display Characteristics .....	5
2.2 Optical Characteristics .....	6
<b>3. Functional Block Diagram</b> .....	<b>9</b>
<b>4. Absolute Maximum Ratings</b> .....	<b>10</b>
4.1 Absolute Ratings of TFT LCD Module.....	10
4.2 Absolute Ratings of Environment.....	10
<b>5. Electrical Characteristics</b> .....	<b>11</b>
5.1 TFT LCD Module .....	11
5.2 Backlight Unit.....	13
<b>6. Signal Characteristics</b> .....	<b>14</b>
6.1 Pixel Format Image.....	14
6.2 Scanning Direction.....	14
6.3 TFT-LCD Interface Signal Description .....	15
6.4 The Input Data Format.....	16
6.5 TFT-LCD Interface Timing.....	17
6.6 Power ON/OFF Sequence .....	18
<b>7. Connector &amp; Pin Assignment</b> .....	<b>19</b>
7.1 TFT-LCD Signal (CN1): LVDS Connector .....	19
7.2 LED Backlight Unit (CN2): Driver Connector .....	19
7.3 LED Backlight Unit (CN4): Light bar Connector .....	19
<b>8. Reliability Test Criteria</b> .....	<b>20</b>
<b>9. Mechanical Characteristics</b> .....	<b>21</b>
9.1 LCM Outline Dimension (Front View).....	21
9.2 LCM Outline Dimension (Rear View) .....	22
<b>10. Label and Packaging</b> .....	<b>23</b>
10.1 Shipping Label (on the rear side of TFT-LCD display) .....	23
10.2 Carton Package .....	23
<b>11 Safety</b> .....	<b>24</b>
11.1 Sharp Edge Requirements .....	24
11.2 Materials.....	24
11.3 Capacitors .....	24
11.4 National Test Lab Requirement.....	24

## Record of Revision

Version and Date	Page	Old description	New Description
0.0 2012/07/15	All	First Edition	
0.1 2012/09/11	22	LVDS CN1 pin1 is on the right	CN1 pin1 is on the left
0.2 2013/04/20	6	Contrast ratio typ=1400 Weight 350g	Contrast ratio typ=3000 Weight 295g
	11	I <sub>VDD</sub> typ=200	I <sub>VDD</sub> typ=20
	21		Correct some drawing dimension 
	23	Max. Weight: 14.5 kg / per carton	Max. Weight: 15.5 kg / per carton
1.0 2013/07/20	6		Add R,G,B chromaticity
	10	Absolute ratings of environment operation and storage humidity 95	Operation and storage humidity 90 Add dew point chart
	13		Add maximum value of backlight LED forward voltage and power consumption
	20		Add Note 3, Note 4
1.1 2013/10/15	6	Brightness 400nits typ./300nits min.	Brightness 470nits typ./350nits min.

## 1. Operating Precautions

- 1) Since front polarizer is easily damaged, please be cautious and not to scratch it.
- 2) Be sure to turn off power supply when inserting or disconnecting from input connector.
- 3) Wipe off water drop immediately. Long contact with water may cause discoloration or spots.
- 4) When the panel surface is soiled, wipe it with absorbent cotton or soft cloth.
- 5) Since the panel is made of glass, it may be broken or cracked if dropped or bumped on hard surface.
- 6) To avoid ESD (Electro Static Discharge) damage, be sure to ground yourself before handling TFT-LCD Module.
- 7) Do not open nor modify the module assembly.
- 8) Do not press the reflector sheet at the back of the module to any direction.
- 9) In case if a module has to be put back into the packing container slot after it was taken out from the container, do not press the center of the LED light bar edge. Instead, press at the far ends of the LED light bar edge softly. Otherwise the TFT Module may be damaged.
- 10) At the insertion or removal of the Signal Interface Connector, be sure not to rotate nor tilt the Interface Connector of the TFT Module.
- 11) TFT-LCD Module is not allowed to be twisted & bent even force is added on module in a very short time. Please design your display product well to avoid external force applying to module by end-user directly.
- 12) Small amount of materials without flammability grade are used in the TFT-LCD module. The TFT-LCD module should be supplied by power complied with requirements of Limited Power Source (IEC60950 or UL1950), or be applied exemption.
- 13) Severe temperature condition may result in different luminance, response time and lamp ignition voltage.
- 14) Continuous operating TFT-LCD display under low temperature environment may accelerate lamp exhaustion and reduce luminance dramatically.
- 15) The data on this specification sheet is applicable when LCD module is placed in landscape position.
- 16) Continuous displaying fixed pattern may induce image sticking. It's recommended to use screen saver or shuffle content periodically if fixed pattern is displayed on the screen.

## 2. General Description

This specification applies to the Color Active Matrix Liquid Crystal Display G104XVN01.0 composed of a TFT-LCD display, a driver and power supply circuit, and a LED backlight system.

The screen format is intended to support XGA (1024(H) x 768(V)) screen and 16.2M (RGB 8-bits) or 262k colors (RGB 6-bits).

LED driving board for backlight unit is included in G104XVN01.0.

G104XVN01.0 designed with wide viewing angle; wide temperature and long life LED backlight is well suited for industrial applications.

G104XVN01.0 is a RoHS product.

### 2.1 Display Characteristics

The following items are characteristics summary on the table under 25 °C condition:

Items	Unit	Specifications
Screen Diagonal	[inch]	10.4
Active Area	[mm]	210.4 (H) x 157.8 (V)
Pixels H x V		1024 x 3(RGB) x 768
Pixel Pitch	[mm]	0.2055 x 0.2055
Pixel Arrangement		R.G.B. Vertical Stripe
Display Mode		PSA, Normally Black
Nominal Input Voltage VDD	[Volt]	3.3 (typ.)
Typical Power Consumption	[Watt]	6.0W All black pattern
Weight	[Grams]	295(Typ.)
Physical Size	[mm]	238.6(H) x 175.8(V) x 6.5(D)(Typ.)
Electrical Interface		1 channel LVDS
Surface Treatment		Anti-glare, Hardness 3H
Support Color		16.2M / 262K colors
Temperature Range		
Operating	[°C]	-30 to +80
Storage (Non-Operating)	[°C]	-30 to +80
RoHS Compliance		RoHS Compliance

## 2.2 Optical Characteristics

The optical characteristics are measured under stable conditions at 25°C (Room Temperature):

Item	Unit	Conditions	Min.	Typ.	Max.	Remark
White Luminance	[cd/m <sup>2</sup> ]	I <sub>F</sub> = 80mA/1 LED Line (center point)	350	450	-	Note 1
Uniformity	%	5 Points	75	80	-	Note 2, 3
Contrast Ratio			2500	3000	-	Note 4
Response Time	[msec]	Rising	-	10	20	Note 5
	[msec]	Falling	-	20	30	
	[msec]	Raising + Falling	-	30	50	
Viewing Angle	[degree] [degree]	Horizontal (Right) CR = 10 (Left)	-	89	-	Note 6
	[degree] [degree]	Vertical (Upper) CR = 10 (Lower)	-	89	-	
Color / Chromaticity Coordinates (CIE 1931)		Red x	0.570	0.620	0.670	
		Red y	0.280	0.330	0.380	
		Green x	0.300	0.350	0.400	
		Green y	0.530	0.580	0.630	
		Blue x	0.100	0.150	0.200	
		Blue y	0.010	0.060	0.110	
		White x	0.263	0.313	0.363	
		White y	0.279	0.329	0.379	
Color Gamut	%		-	60	-	

Note 1: Measurement method

Equipment Pattern Generator, Power Supply, Digital Voltmeter, Luminance meter (SR\_3 or equivalent)

Aperture 1° with 50cm viewing distance

Test Point Center

Environment < 1 lux

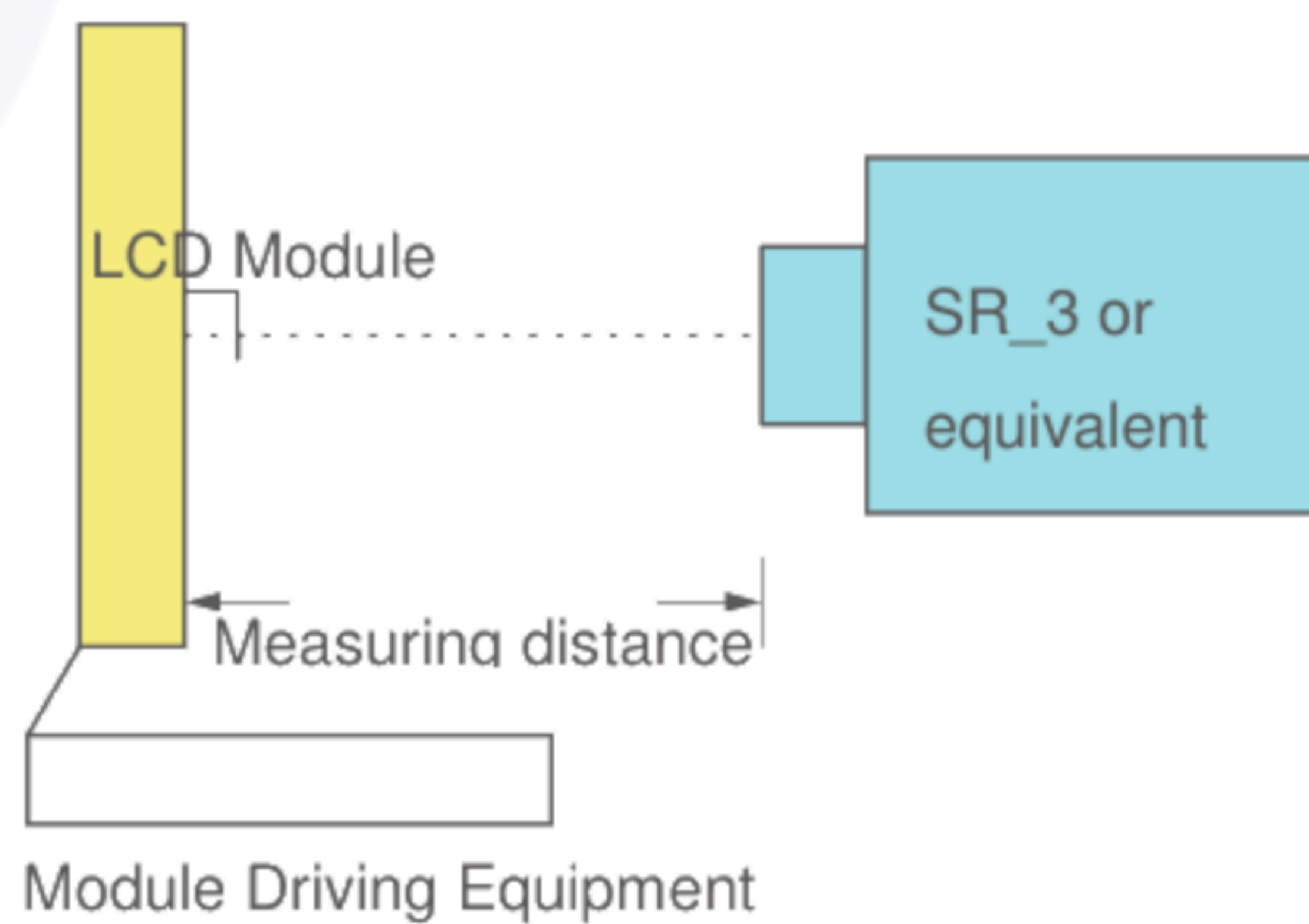

Note 2: Definition of 5 points position (Display active area: 210.4mm (H) x 157.8mm (V))

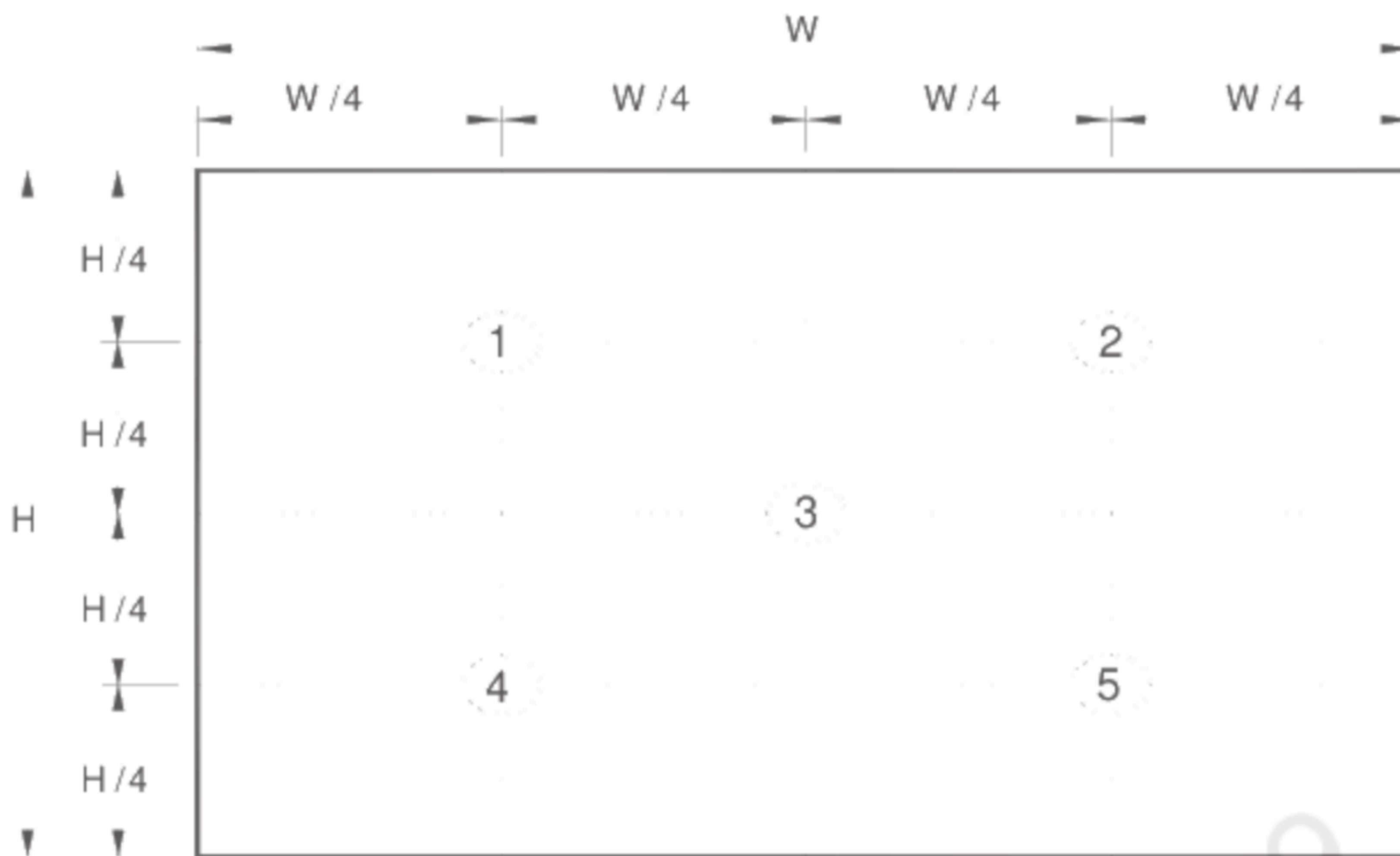

Note 3: The luminance uniformity of 5 points is defined by dividing the minimum luminance values by the maximum test point luminance

$$\delta_{w9} = \frac{\text{Minimum Brightness of five points}}{\text{Maximum Brightness of five points}}$$

Note 4: Definition of contrast ratio (CR):

$$\text{Contrast ratio (CR)} = \frac{\text{Brightness on the "White" state}}{\text{Brightness on the "Black" state}}$$

Note 5: Definition of response time:

The output signals of photo detector are measured when the input signals are changed from "White" to "Black" (falling time) and from "Black" to "White" (rising time), respectively. The response time interval is between 10% and 90% of amplitudes. Please refer to the figure as below.

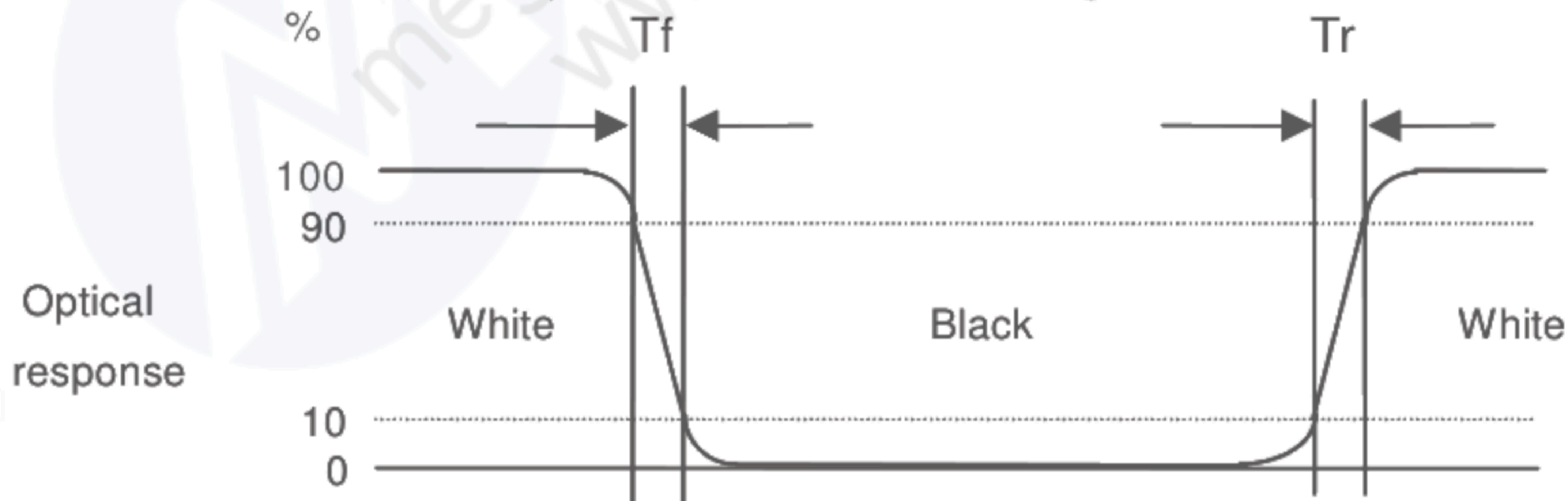

Note 6: Definition of viewing angle

Viewing angle is the measurement of contrast ratio  $\geq 10$ , at the screen center, over a 180° horizontal and 180° vertical range (off-normal viewing angles). The 180° viewing angle range is broken down as below: 90° ( $\theta$ ) horizontal left and right, and 90° ( $\Phi$ ) vertical high (up) and low (down). The measurement direction is typically perpendicular to the display surface with the screen rotated to its center to develop the desired

measurement viewing angle.

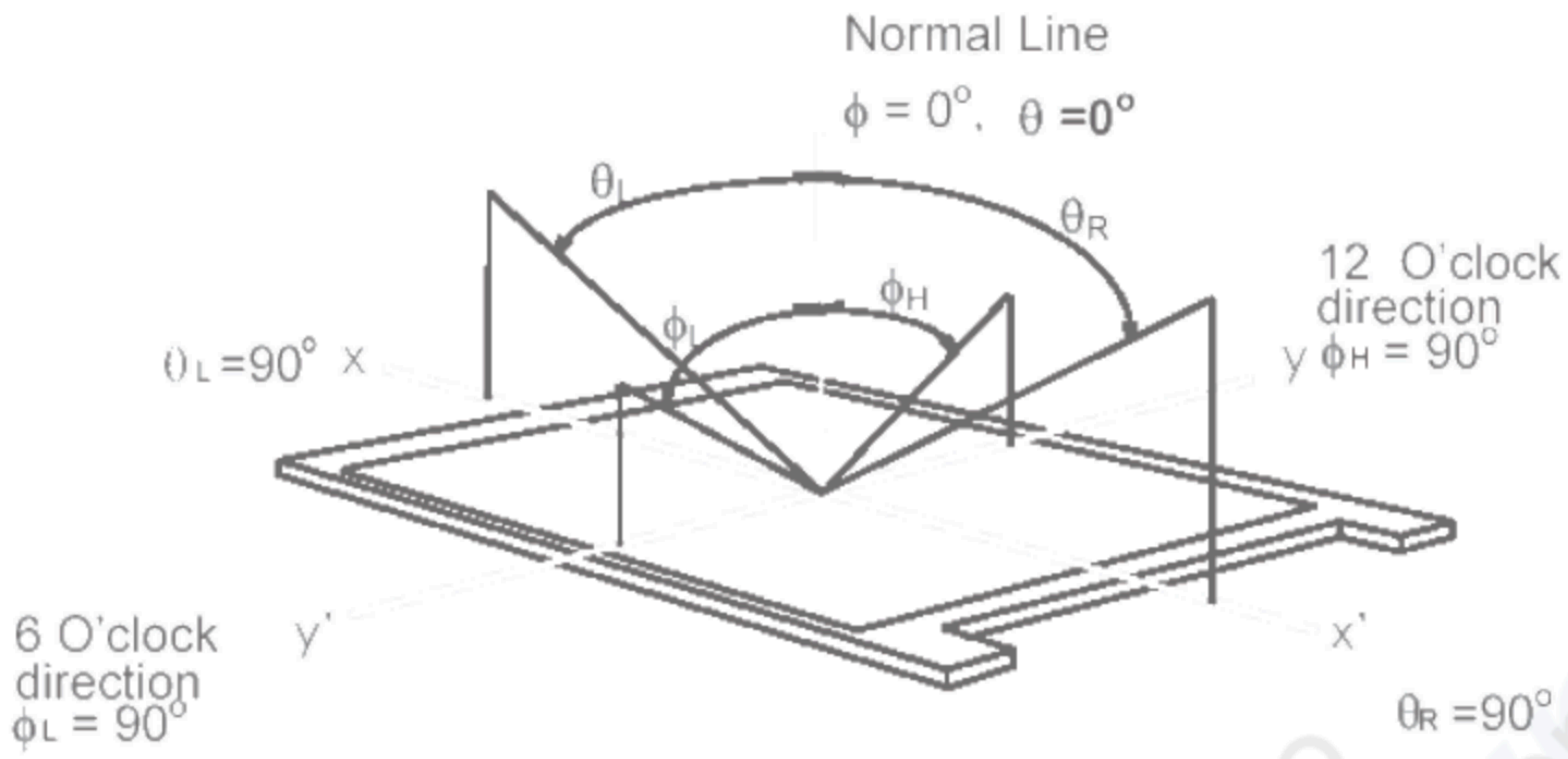

Tel: +86 13510585989  
 megatech@megasourceel.com  
 www.megasourceel.com

### 3. Functional Block Diagram

The following diagram shows the functional block of the 10.4 inch color TFT/LCD module:

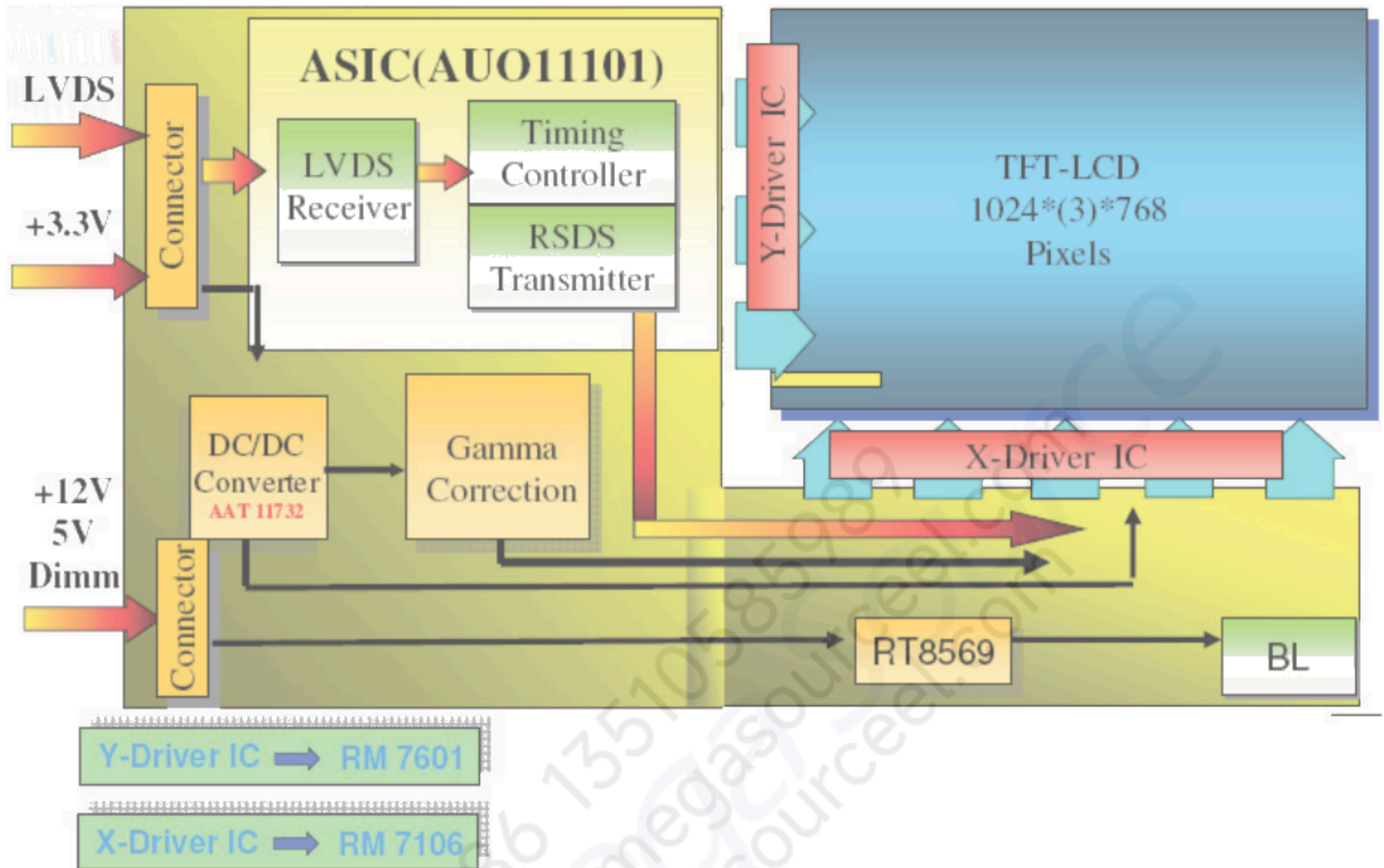

## 4. Absolute Maximum Ratings

### 4.1 Absolute Ratings of TFT LCD Module

Item	Symbol	Min	Max	Unit
Logic/LCD Drive Voltage	Vin	-0.3	6	[Volt]

### 4.2 Absolute Ratings of Environment

Item	Symbol	Min	Max	Unit
Operating Temperature	TOP	-30	+80	[°C]
Operation Humidity	HOP	5	90	[%RH]
Storage Temperature	TST	-30	+80	[°C]
Storage Humidity	HST	5	90	[%RH]

Note: Maximum Wet-Bulb should be 39°C and no condensation.

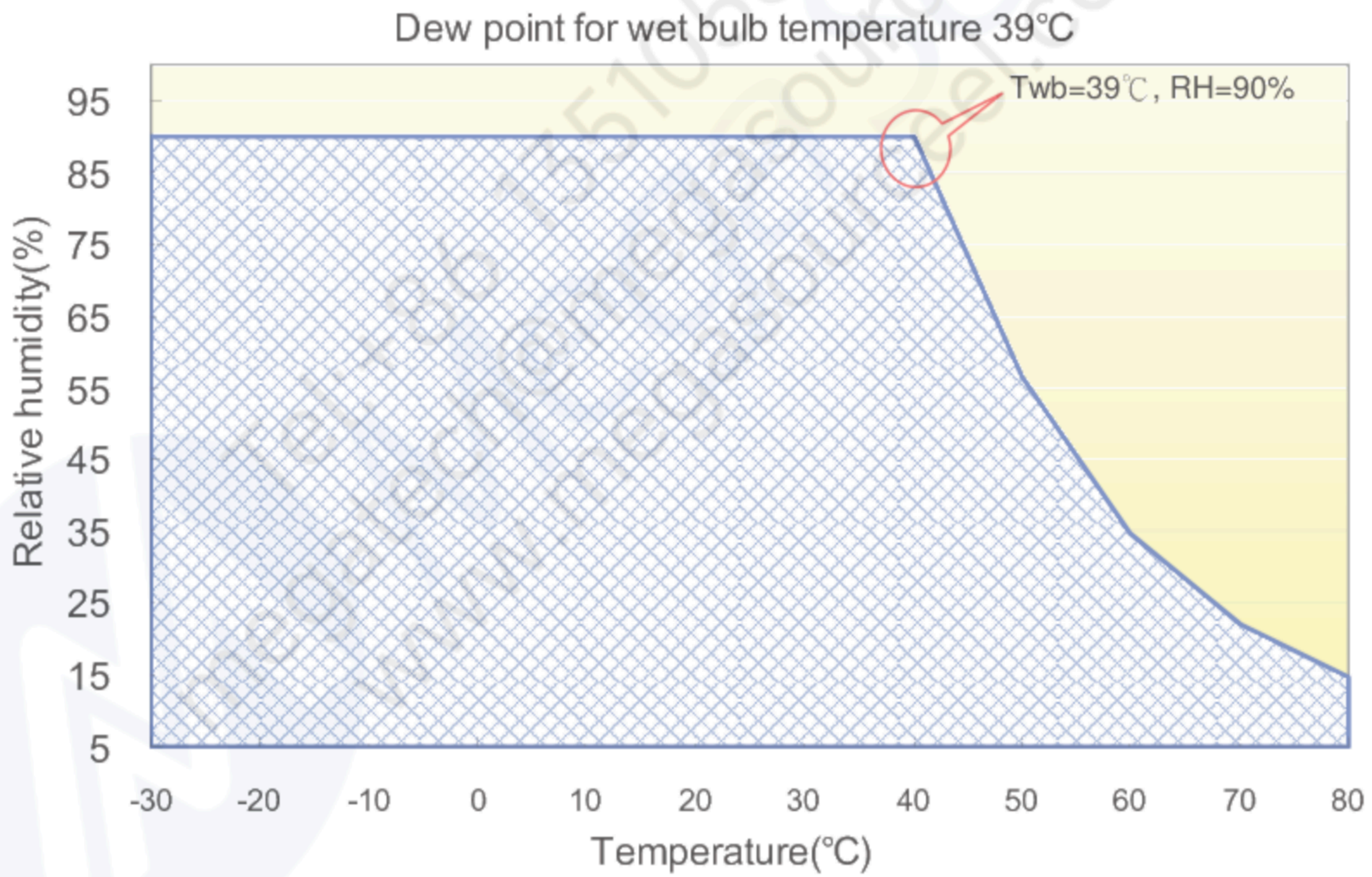

## 5. Electrical Characteristics

### 5.1 TFT LCD Module

#### 5.1.1 Power Specification

Symbol	Parameter	Min	Typ	Max	Units	Remark
VDD	Logic/LCD Input Voltage	3.1	3.3	3.5	[Volt]	
I <sub>VDD</sub>	LCD Input Current	-	300	-	[mA]	VDD=3.3V at 60 HZ, all Black Pattern
P <sub>VDD</sub>	LCD Power consumption	-	0.99	-	[Watt]	VDD=3.3V at 60 HZ, all Black Pattern
I <sub>rush LCD</sub>	LCD Inrush Current	-	-	1.5	[A]	Note 1; VDD=3.3V Black Pattern, Rising time=470us
VDD <sub>rp</sub>	Allowable Logic/LCD Drive Ripple Voltage	-	-	100	[mV] p-p	VDD=3.3V at 60 HZ, all Black Pattern

Note 1: Measurement condition:

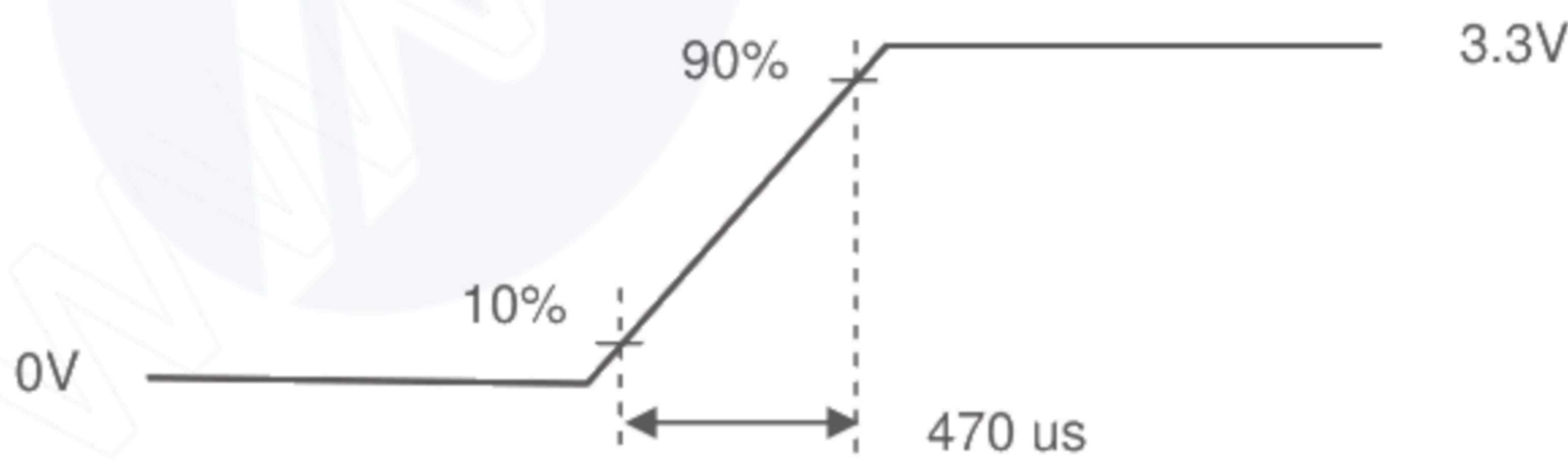
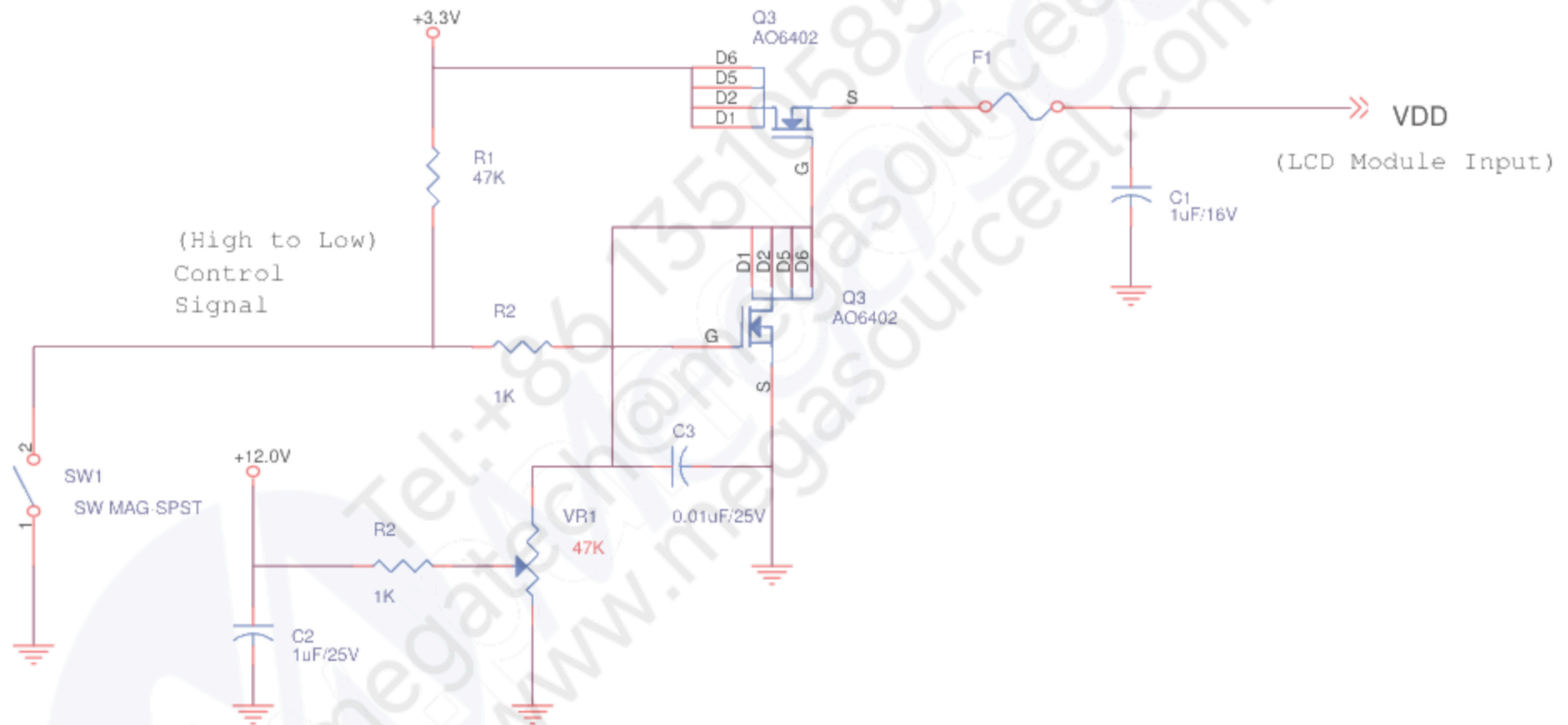

VDD rising time

### 5.1.2 Signal Electrical Characteristics

Input signals shall be low or Hi-Z state when VDD is off.

Symbol	Item	Min.	Typ.	Max.	Unit	Remark
VTH	Differential Input High Threshold	-	-	100	[mV]	VCM=1.2V
VTL	Differential Input Low Threshold	100	-	-	[mV]	VCM=1.2V
VID	Input Differential Voltage	100	400	600	[mV]	
VICM	Differential Input Common Mode Voltage	1.1	-	1.45	[V]	VTH/VTL=+-100mV

Note: LVDS Signal Waveform.

#### Single-end Signal

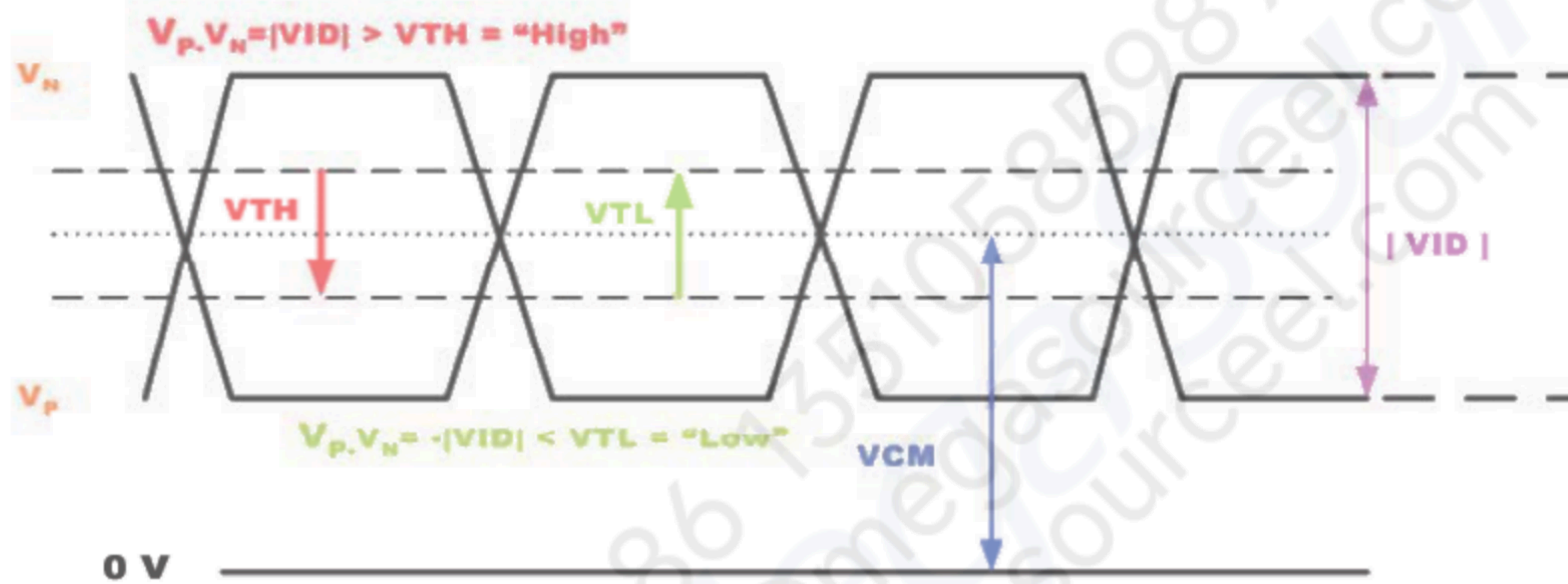

#### Differential Signal

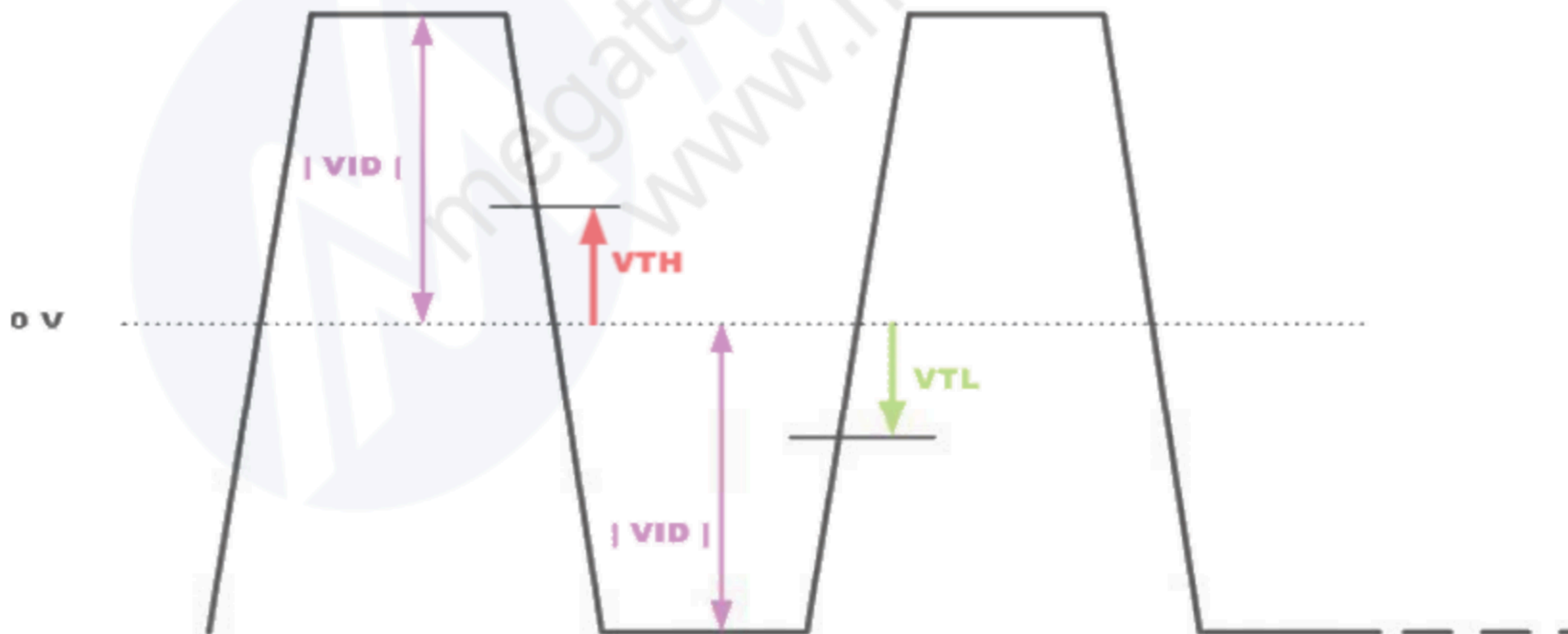

## 5.2 Backlight Unit

### 5.2.1 Parameter guideline for LED backlight

Following characteristics are measured under a stable condition using a inverter at 25°C . (Room Temperature):

Symbol	Parameter	Min.	Typ.	Max.	Unit	Remark
VCC	Input Voltage	10.8	12	12.6	[Volt]	
I <sub>VCC</sub>	Input Current	-	0.5	-	[A]	100% PWM Duty
P <sub>VCC</sub>	Power Consumption	-	6	-	[Watt]	100% PWM Duty
I <sub>INRUSH LED</sub>	Inrush Current	-	-	3	A	V <sub>LED</sub> rising time ~ 470us
F <sub>PWM</sub>	Dimming Frequency	200	-	20K	[Hz]	
V <sub>LED ON/OFF</sub>	On Control Voltage	2.5	3.3	5.5	Volt	Note 4,5
	Off Control Voltage	-	-	0.8	Volt	
V <sub>PWM DIM</sub>	Swing Voltage	2.5	3.3	5.5	[Volt]	
	Dimming duty cycle	5	-	100	%	
I <sub>F</sub>	LED Forward Current	-	80	-	[mA]	Ta = 25°C
V <sub>F</sub>	LED Forward Voltage	-	-	34.2	[Volt]	I <sub>F</sub> = 80mA, Ta = -30°C
		-	29.7	32.4	[Volt]	I <sub>F</sub> = 80mA, Ta = 25°C
		-	-	31.5	[Volt]	I <sub>F</sub> = 80mA, Ta = 80°C
P <sub>LED</sub>	LED Power Consumption	-	4.75	5.47	[Watt]	2 String of LED Light Bar
<b>Operation Life</b>		50,000	-	-	Hrs	I <sub>F</sub> =80mA, Ta= 25°C

Note 1: Ta means ambient temperature of TFT-LCD module.

Note 2: VCC, I<sub>VCC</sub>, I<sub>rush LED</sub>, P<sub>VCC</sub> are defined for LED backlight.(100% duty of PWM dimming)

Note 3: I<sub>F</sub>, V<sub>F</sub> are defined for one channel LED. There are two LED channel in back light unit.

Note 4: PWM dimming function can be operated by PWM signal. PWM duty cycle can adjust white Luminance.

(PWM High: ON and PWM Low: OFF)

Note 5: PWM signal can not be floating and pull-down to ground when waiting.

Note 6: If G104XVN01.0 module is driven by high current or at high ambient temperature & humidity condition. The operating life will be reduced.

Note 7: Operating life means brightness goes down to 50% initial brightness. Minimum operating life time is estimated data.

## 6. Signal Characteristics

### 6.1 Pixel Format Image

Following figure shows the relationship between input signal and LCD pixel format.

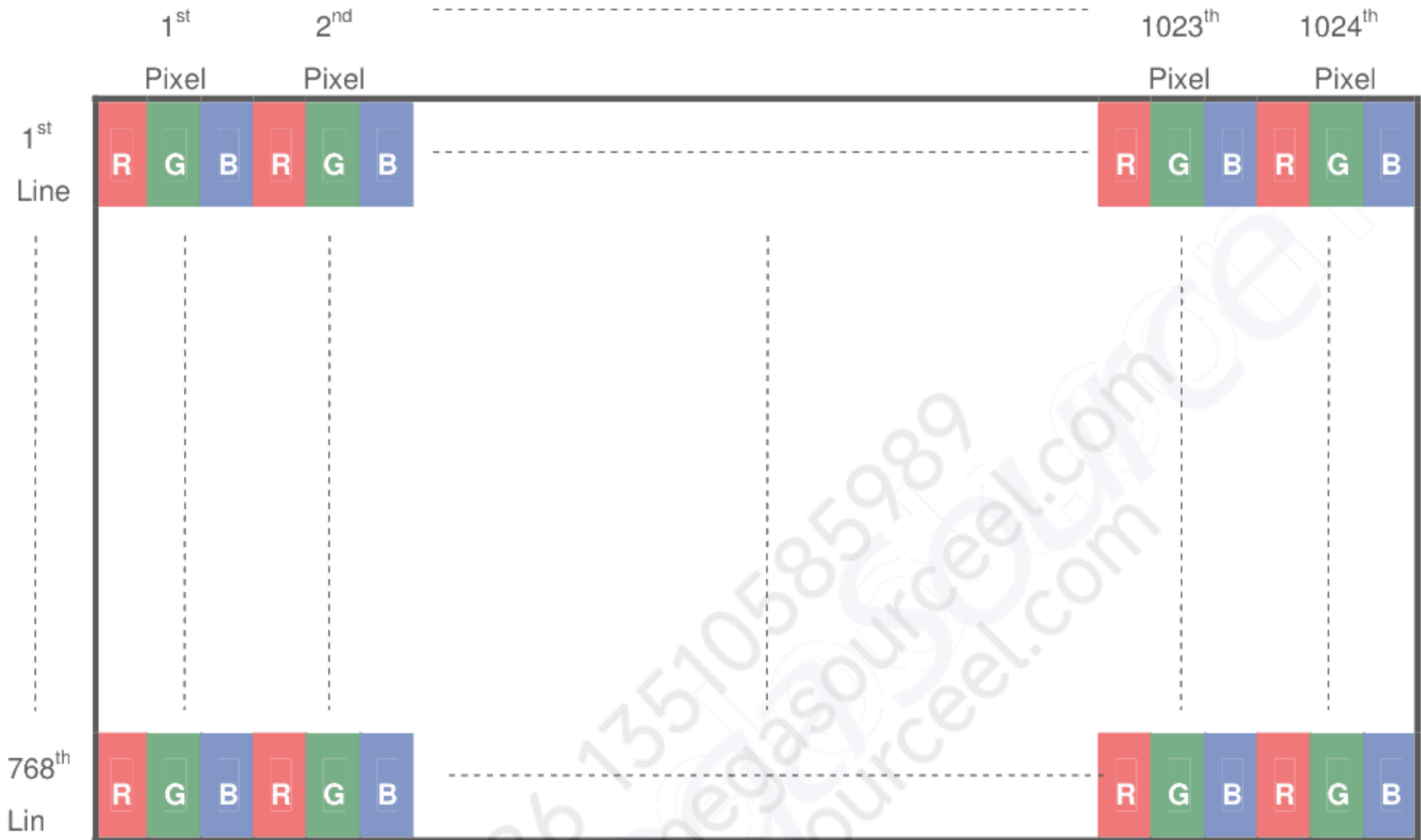

### 6.2 Scanning Direction

The following figures show the image seen from the front view. The arrow indicates the direction of scan.

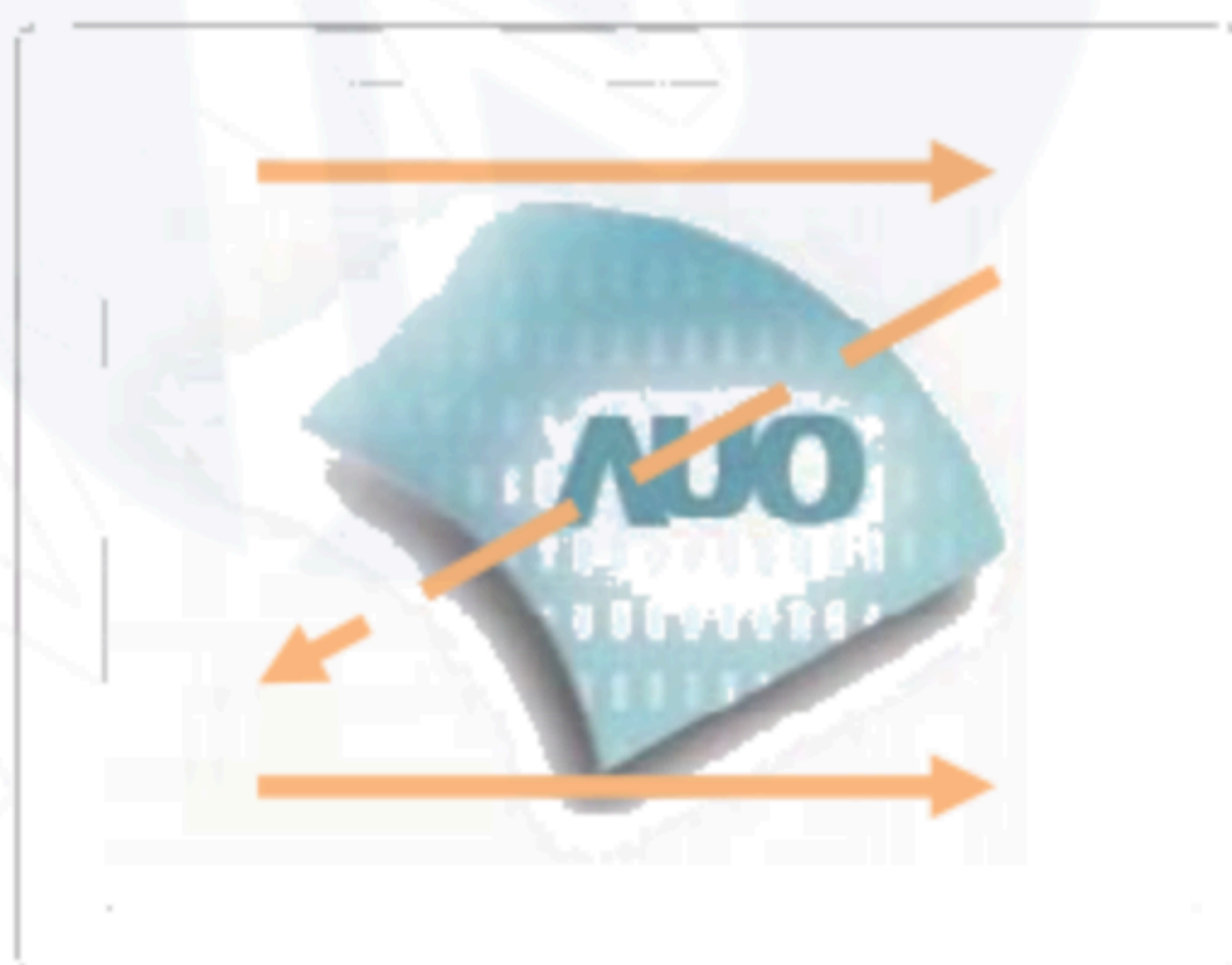

Fig. 1 Normal scan (Pin24, **Reverse** = Low or NC)



Fig. 2 Reverse scan (Pin24, **Reverse** = High)

### 6.3 TFT-LCD Interface Signal Description

The module using a LVDS receiver embaded in AUO's ASIC. LVDS is a differential signal technology for LCD interface and a high-speed data transfer device.

Pin No.	Signal Name	Description
1	NC	No Connection
2	GND	Ground
3	Rin3+	Positive LVDS differential data input (+)
4	Rin3-	Negative LVDS differential data input (-)
5	GND	Ground
6	CLK+	Clock signal (+)
7	CLK-	Clock signal (-)
8	GND	Ground
9	Rin2+	Positive LVDS differential data input (+)
10	Rin2-	Negative LVDS differential data input (-)
11	GND	Ground
12	Rin1+	Positive LVDS differential data input (+)
13	Rin1-	Negative LVDS differential data input (-)
14	GND	Ground
15	Rin0+	Positive LVDS differential data input (+)
16	Rin0-	Negative LVDS differential data input (-)
17	GND	Ground
18	NC	No Connection
19	GND	Ground
20	SEL6/8	Selection for 6 bits/8bits LVDS data input Low or NC -> 8 bit Input Mode High -> 6bit Input Mode
21	NC	No Connection
22	NC	No Connection
23	NC	No Connection
24	Reverse	Reverse Panel Function (Display Rotation)
25	GND	Ground
26	GND	Ground
27	GND	Ground
28	VCC	Power supply: +3.3V
29	VCC	Power supply: +3.3V
30	VCC	Power supply: +3.3V

Note 1: Input Signals shall be in low status when VDD is off.

Note 2: High stands for "3.3V", Low stands for "0V", NC stands for "No Connection".

Note 3: RSV stands for "Reserved".

## 6.4 The Input Data Format

### 6.4.1 SEL68

**SEL68 = "High" for 6 bits LVDS Input**



**SEL68 = "Low" or "NC" for 8 bits LVDS Input**

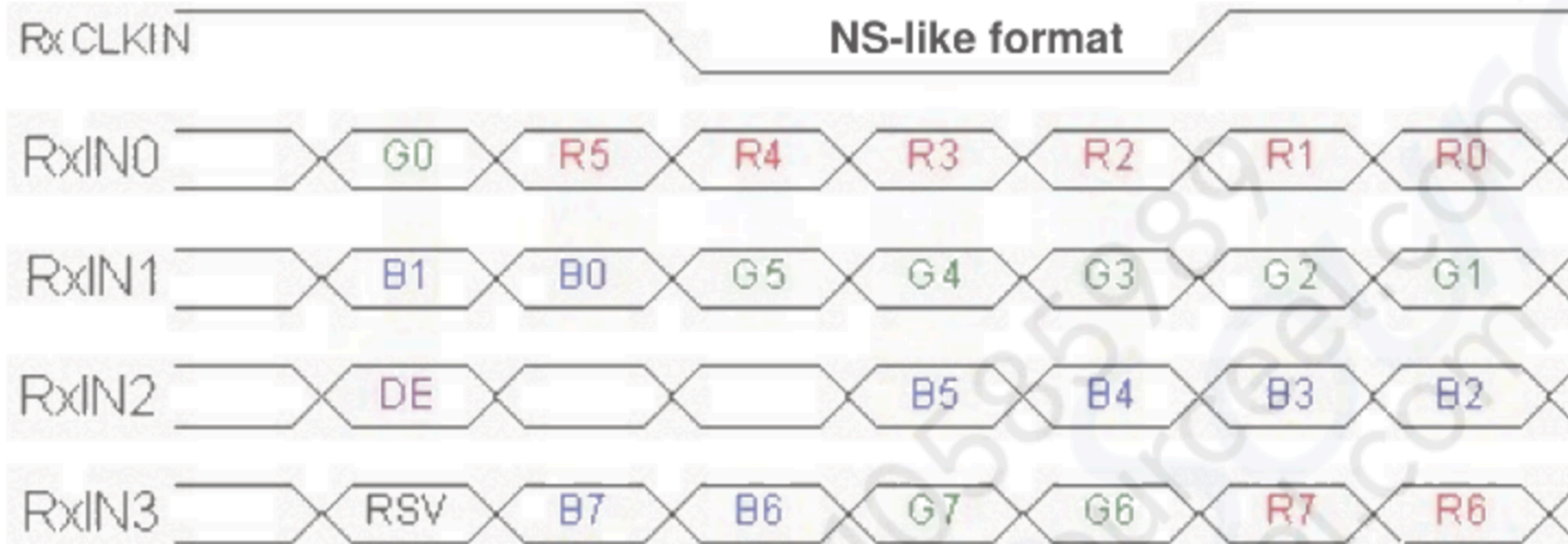

**Note1:** Please follow PSWG.

**Note2:** R/G/B data 7:MSB, R/G/B data 0:LSB

Signal Name	Description	Remark
R7	Red Data 7	Red-pixel Data
R6	Red Data 6	
R5	Red Data 5	
R4	Red Data 4	
R3	Red Data 3	
R2	Red Data 2	
R1	Red Data 1	
R0	Red Data 0	
G7	Green Data 7	Green-pixel Data
G6	Green Data 6	
G5	Green Data 5	
G4	Green Data 4	
G3	Green Data 3	
G2	Green Data 2	
G1	Green Data 1	
G0	Green Data 0	
B7	Blue Data 7	Blue-pixel Data
B6	Blue Data 6	
B5	Blue Data 5	
B4	Blue Data 4	
B3	Blue Data 3	
B2	Blue Data 2	
B1	Blue Data 1	
B0	Blue Data 0	
RxCLKIN	LVDS Data Clock	
DE	Data Enable Signal	When the signal is high, the pixel data shall be valid to be displayed.

Note: Output signals from any system shall be low or Hi-Z state when VDD is off.

## 6.5 TFT-LCD Interface Timing

### 6.5.1 Timing Characteristics

Signal	Symbol	Min.	Typ.	Max.	Unit	
Clock Frequency	$1/T_{\text{Clock}}$	50	65	81	MHz	
Vertical Section	Period	$T_V$	776	806	1023	$T_{\text{Line}}$
	Active	$T_{VD}$	768	768	768	
	Blanking	$T_{VB}$	8	38	256	
Horizontal Section	Period	$T_H$	1054	1344	2047	$T_{\text{Clock}}$
	Active	$T_{HD}$	1024	1024	1024	
	Blanking	$T_{HB}$	30	320	1023	
Frame Rate	F	50	60	75	Hz	

Note : DE mode.

### 6.5.2 Input Timing Diagram

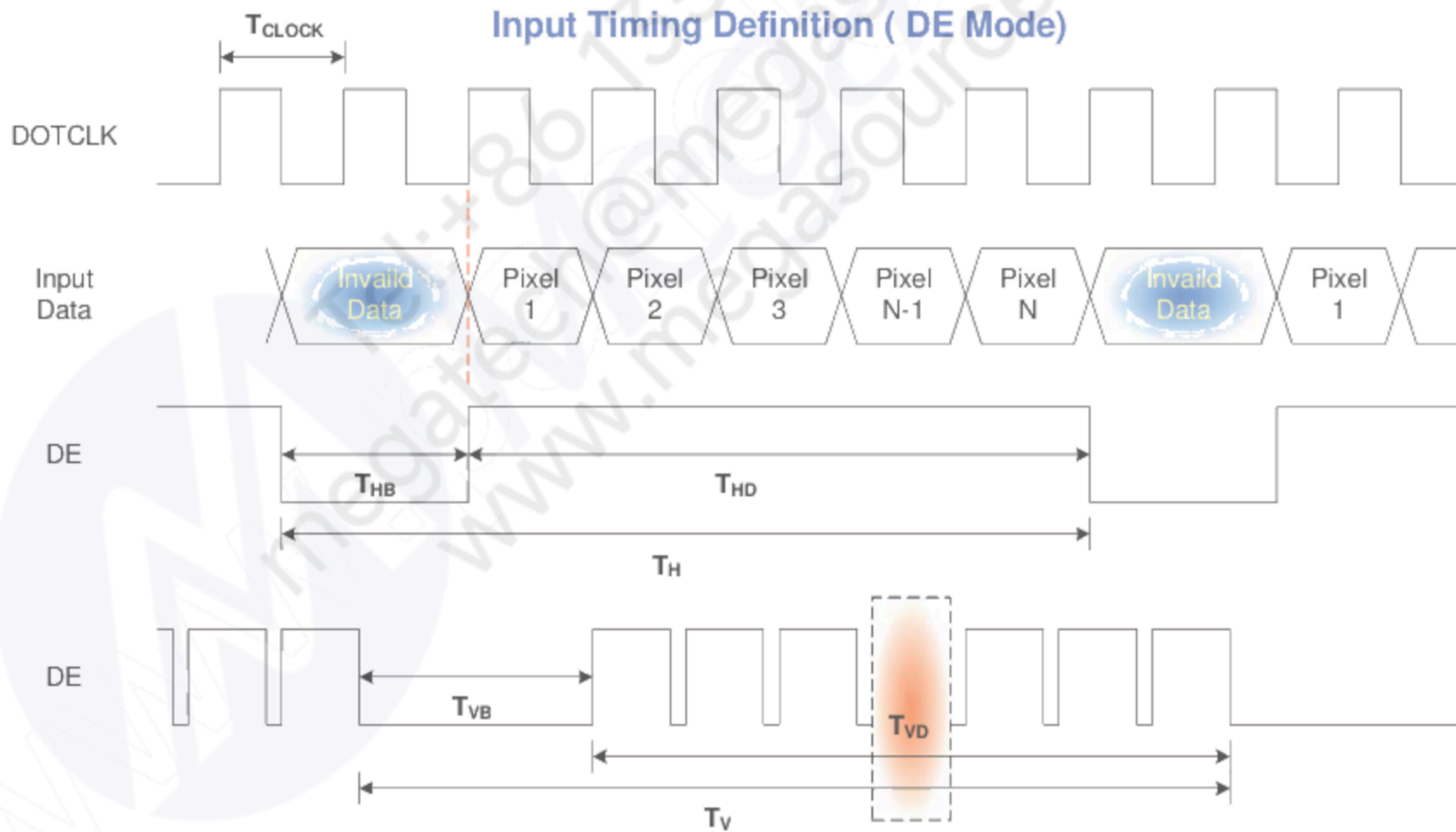

## 6.6 Power ON/OFF Sequence

VDD power and lamp on/off sequence is as below. Interface signals are also shown in the chart. Signals from any system shall be Hi-Z state or low level when VDD is off.

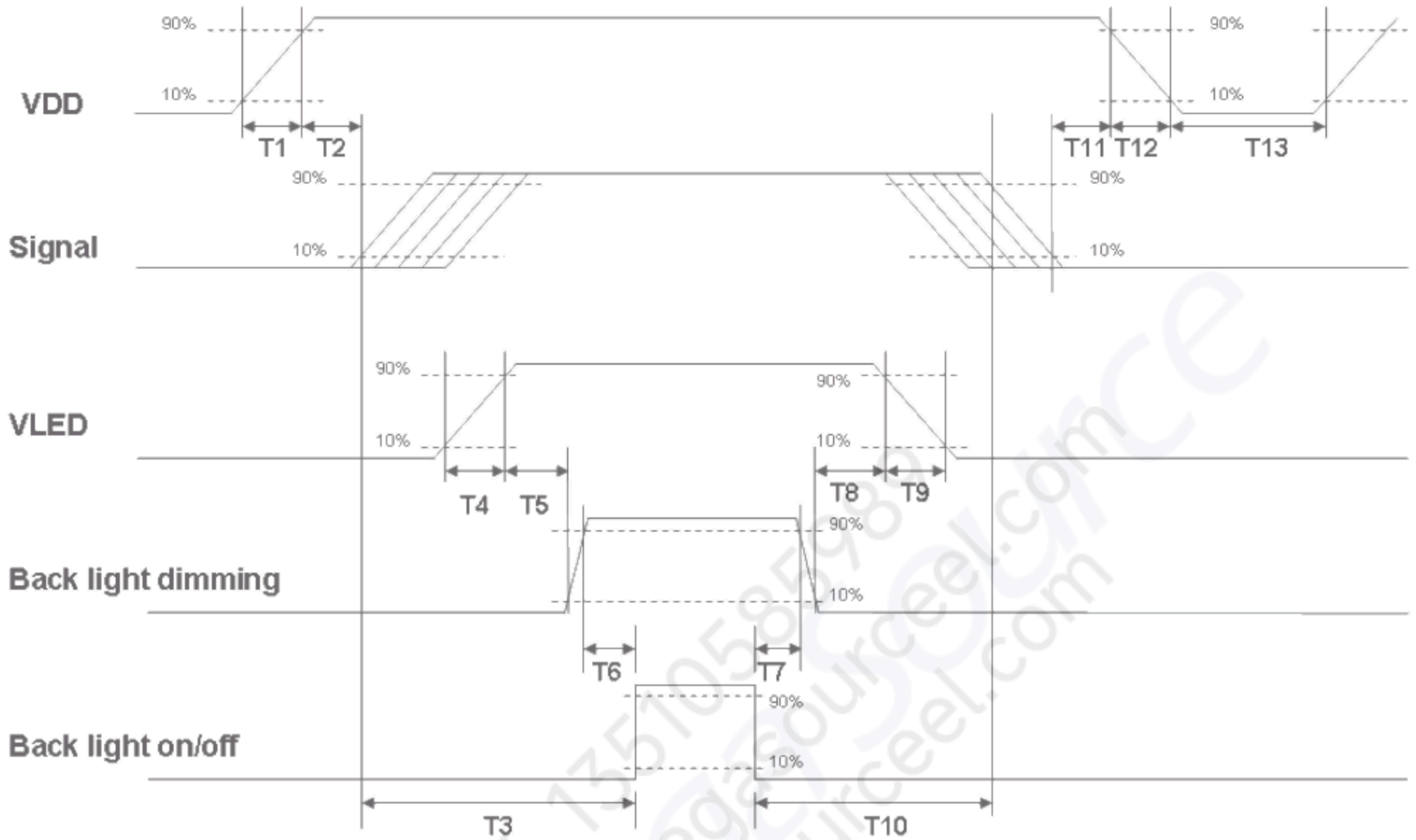

**Power ON/OFF sequence timing**

Parameter	Value			Units
	Min.	Typ.	Max.	
T1	0.5	-	10	[ms]
T2	30	40	50	[ms]
T3	200	--	--	[ms]
T4	0.5	--	10	[ms]
T5	10	-	-	[ms]
T6	10	-	-	[ms]
T7	0	-	-	[ms]
T8	10	-	-	[ms]
T9	--	--	10	[ms]
T10	110	--	--	[ms]
T11	0	16	50	[ms]
T12	-	-	10	[ms]
T13	1000	-	-	[ms]

The above on/off sequence should be applied to avoid abnormal function in the display. Please make sure to turn off the power when you plug the cable into the input connector or pull the cable out of the connector.

## 7. Connector & Pin Assignment

Physical interface is described as for the connector on module. These connectors are capable of accommodating the following signals and will be following components.

### 7.1 TFT-LCD Signal (CN1): LVDS Connector

<b>Connector Name / Designation</b>	<b>Signal Connector</b>
Manufacturer	JAE or compatible
Connector Model Number	FI-XPB30SRLAHF11 or compatible
Adaptable Plug	FI-X30HL or Compatible or compatible

Pin No.	Symbol	Pin No.	Symbol
1	NC	16	Rin0-
2	GND	17	GND
3	Rin3+	18	NC
4	Rin3-	19	GND
5	GND	20	SEL6/8
6	CLK+	21	NC
7	CLK-	22	NC
8	GND	23	NC
9	Rin2+	24	Reverse
10	Rin2-	25	GND
11	GND	26	GND
12	Rin1+	27	GND
13	Rin1-	28	VCC
14	GND	29	VCC
15	Rin0+	30	VCC

### 7.2 LED Backlight Unit (CN2): Driver Connector

<b>Connector Name / Designation</b>	<b>Lamp Connector</b>
Manufacturer	ENTERY or compatible
Connector Model Number	3808K-F05N-02R or compatible
Mating Model Number	H208K-P05N-02B or compatible

Pin No.	symbol	description
Pin1	VCC	12V input
Pin2	VCC	12V input
Pin3	GND	GND
Pin4	Dimming	PWM
Pin5	On/OFF	3.3V or 5V-ON,0V-OFF

### 7.3 LED Backlight Unit (CN3): Light bar Connector

Connector Name / Designation	Lamp Connector
Manufacturer	ENTERY or compatible
Connector Model Number	H208K-P03N-02R or compatible
Mating Model Number(CN3)	3808K-F03N-02B or compatible

Pin No.	symbol	description	Color
Pin1	H	LED anode	Red
Pin2	L	LED cathode	White
Pin3	L	LED cathode	White

## 8. Reliability Test Criteria

Items	Required Condition	Note
Temperature Humidity Bias	40°C , 90%RH, 300 hours	Note3
High Temperature Operation	80°C , 300 hours	Note3
Low Temperature Operation	-30°C , 300 hours	Note3
Hot Storage	80°C , 300 hours	Note3
Cold Storage	-30°C , 300 hours	Note3
Thermal Shock Test	-20°C/ 30 min, 60°C/ 30 min, 100cycles, 40°C minimum ramp rate	Note3
Hot Start Test	80°C/ 1Hr min. power on/off per 5 minutes, 5 times	
Cold Start Test	-30°C/ 1Hr min. power on/off per 5 minutes, 5 times	
Shock Test (Non-Operating)	50G, 20ms, Half-sine wave, ( ±X, ±Y, ±Z)	
Vibration Test (Non-Operating)	1.5G, (10~200Hz, Sine wave) 30 mins/axis, 3 direction (X, Y, Z)	
On/off test	On/10 sec, Off/10 sec, 30,000 cycles	Note4
ESD	Contact Discharge: ± 8KV, 150pF(330Ω ) 1sec, 8 points, 25 times/ point Air Discharge: ± 15KV, 150pF(330Ω ) 1sec, 8 points, 25 times/ point	Note1
EMI	30-230 MHz, limit 40 dBu V/m, 230-1000 MHz, limit 47 dBu V/m	

Note1: According to EN61000-4-2, ESD class B: Some performance degradation allowed. No data lost  
Self-recoverable. No hardware failures.

Note2:

- Water condensation is not allowed for each test items.
- Each test is done by new TFT-LCD module. Don't use the same TFT-LCD module repeatedly for reliability test.
- The reliability test is performed only to examine the TFT-LCD module capability.

Note3. To inspect TFT-LCD module after reliability test, please store it at room temperature and room humidity for 2 hours at least in advance.

Note4. Judged by the on/off testing results of AUO's standard w/o functional fail



## 9.2 LCM Outline Dimension (Rear View)



## 10. Label and Packaging

### 10.1 Shipping Label (on the rear side of TFT-LCD display)

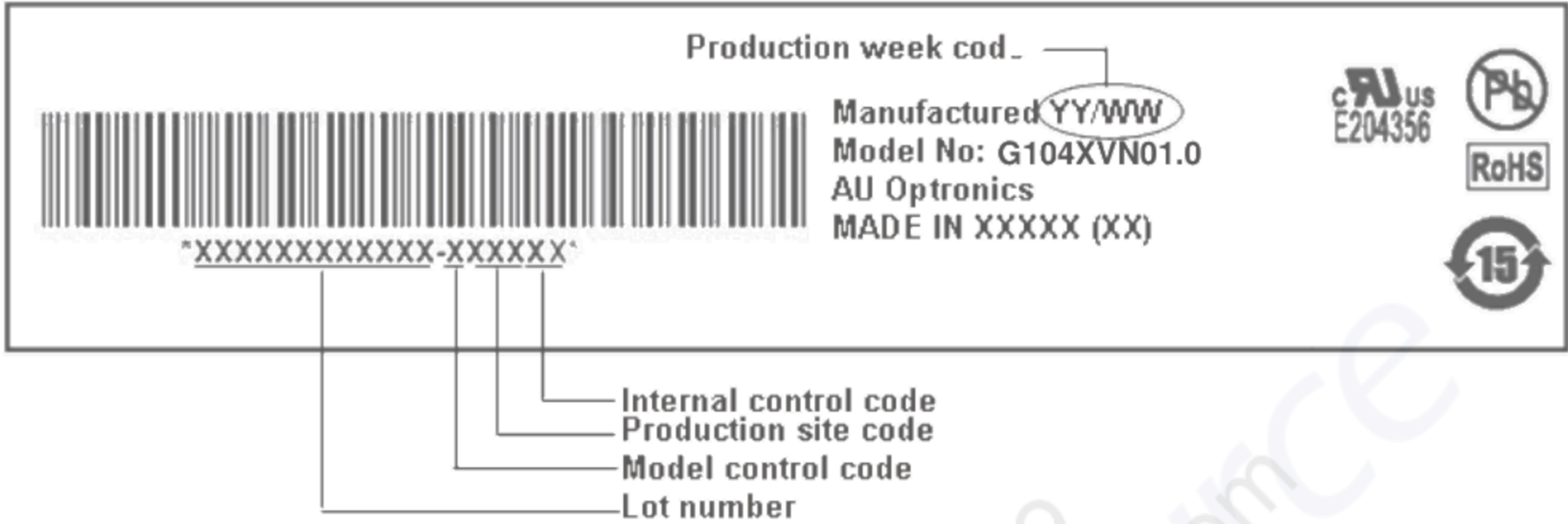

### 10.2 Carton Package

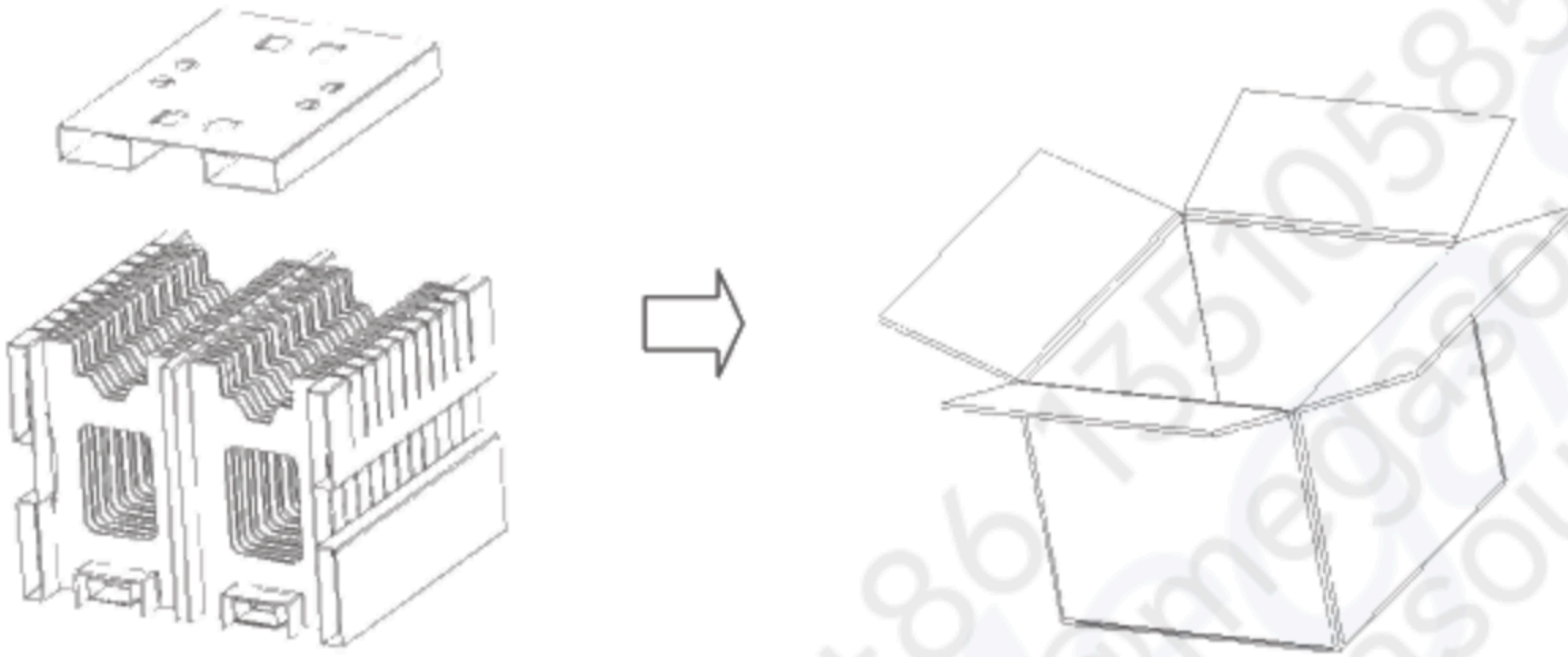

**Note:**

1. Max. Capacity: 40pcs LCD Modules / per carton
2. Max. Weight: 15.5 kg / per carton
3. The outside dimension of carton is 458(L) mm x 412(W) mm x 368(H) mm

## 11 Safety

### 11.1 Sharp Edge Requirements

There will be no sharp edges or comers on the display assembly that could cause injury.

### 11.2 Materials

#### 11.2.1 Toxicity

There will be no carcinogenic materials used anywhere in the display module. If toxic materials are used, they will be reviewed and approved by the responsible AUO toxicologist.

#### 11.2.2 Flammability

All components including electrical components that do not meet the flammability grade UL94-V1 in the module will complete the flammability rating exception approval process.

The printed circuit board will be made from material rated 94-V1 or better. The actual UL flammability rating will be printed on the printed circuit board.

### 11.3 Capacitors

If any polarized capacitors are used in the display assembly, provisions will be made to keep them from being inserted backwards.

### 11.4 National Test Lab Requirement

The display module will satisfy all requirements for compliance to:

**UL 1950, First Edition**

U.S.A. Information Technology Equipment